



**ETHICON**, INC.

a *Johnson & Johnson* company

# WOUND CLOSURE MANUAL



*his manual has been prepared for the medical professional who would like to learn more about the practice of surgery—the dynamics of tissue healing, the principles of wound closure, and the materials available to today’s practitioners. Most important, it touches on some of the critical decisions which must be made on a daily basis to help ensure proper wound closure.*

*ETHICON PRODUCTS, a Johnson & Johnson company, is the world’s leading marketer of surgical sutures and is the only U.S. company that offers an adhesive with microbial protection as an alternative to sutures for topical skin closure.*

*ETHICON enjoys a reputation for developing quality products to enhance the lives of patients and for providing outstanding service to customers. We hope you find this manual useful. But, above all, we hope that it reflects our high regard for the men and women who have chosen the medical profession as a career.*



*David, L. Dunn, M.D., Ph. D.*  
*Jay Phillips Professor and Chairman of Surgery,*  
*University of Minnesota*

*We thank Dr. Dunn for his contributions to the Wound Closure Manual. Dr. Dunn is currently the Jay Phillips Professor and Chairman of Surgery at the University of Minnesota. This department has a long-standing tradition and has attained national and international recognition for excellence in training academic general surgeons and surgical scientists. He is also the Division Chief of General Surgery, Head of Surgical Infectious Diseases, Director of Graduate Studies, and Residency Program Director of the Department of Surgery.*

*Dr. Dunn has published over 400 articles and book chapters in the areas of Surgical Infectious Diseases and Transplantation. He has received regional and nationwide recognition in several academic organizations and is a Past-President of the Surgical Infection Society, the Association for Academic Surgery, the Minnesota Chapter of the American College of Surgeons, the Society of University Surgeons and the Society of University Surgeons Foundation.*

# TABLE OF CONTENTS

## 1 WOUND HEALING AND MANAGEMENT

<b>The Wound</b> .....	2
<i>Recovery of Tensile Strength</i> .....	2
<i>Patient Factors that Affect Wound Healing</i> .....	2
<i>Surgical Principles</i> .....	4
<b>Classification of Wounds</b> .....	5
<b>Types of Wound Healing</b> .....	6
<i>Healing by Primary Intention</i> .....	6
<i>Healing by Second Intention</i> .....	7
<i>Delayed Primary Closure</i> .....	7

## 2 THE SUTURE

<b>What is a Suture?</b> .....	10
<b>Personal Suture Preference</b> .....	10
<b>Suture Characteristics</b> .....	11
<i>Size and Tensile Strength</i> .....	11
<i>Monofilament vs. Multifilament</i> .....	11
<i>Absorbable vs. Nonabsorbable Sutures</i> .....	12
<b>Specific Suturing Materials</b> .....	13
<i>Synthetic Absorbable Sutures</i> .....	14
<i>Nonabsorbable Sutures</i> .....	16
<i>Synthetic Nonabsorbable Sutures</i> .....	17
<b>Common Suturing Techniques</b> .....	18
<i>Ligatures</i> .....	18
<i>The Primary Suture Line</i> .....	19
<i>Continuous Sutures</i> .....	19
<i>Interrupted Sutures</i> .....	22
<i>Deep Sutures</i> .....	22
<i>Buried Sutures</i> .....	22
<i>Purse-String Sutures</i> .....	22
<i>Subcuticular Sutures</i> .....	22
<i>The Secondary Suture Line</i> .....	23
<i>Stitch Placement</i> .....	23

<b>Knot Tying</b> .....	24
<i>Knot Security</i> .....	24
<i>Knot Tying Techniques Most Often Used</i> .....	25
<i>Square Knot</i> .....	25
<i>Surgeon's or Friction Knot</i> .....	26
<i>Deep Tie</i> .....	26
<i>Ligation Using a Hemostatic Clamp</i> .....	26
<i>Instrument Tie</i> .....	26
<i>Endoscopic Knot Tying Techniques</i> .....	26
<i>Cutting the Secured Sutures</i> .....	26
<b>Suture Removal</b> .....	26
<b>Suture Handling Tips</b> .....	27
<b>Suture Selection Procedure</b> .....	27
<i>Surgery within the Abdominal Wall Cavity</i> .....	28
<i>Closing the Abdomen</i> .....	30
<i>Closing Contaminated or Infected Wounds</i> .....	40

## 3 THE SURGICAL NEEDLE

<b>Elements of Needle Design</b> .....	42
<b>Principles of Choosing a Surgical Needle</b> ....	44
<b>Anatomy of a Needle</b> .....	45
<i>The Needle Eye</i> .....	45
<i>The Needle Body</i> .....	46
<i>Straight Needle</i> .....	46
<i>Half-Curved Needle</i> .....	47
<i>Curved Needle</i> .....	47
<i>Compound Curved Needle</i> .....	47
<i>The Needle Point</i> .....	48
<b>Types of Needles</b> .....	48
<i>Conventional Cutting Needles</i> .....	49
<i>Reverse Cutting Needles</i> .....	49
<i>Side Cutting Needles</i> .....	50
<i>Taper Point Needles</i> .....	50
<i>Taper Surgical Needles</i> .....	51
<i>Blunt Point Needles</i> .....	52
<b>Needleholders</b> .....	52
<i>Needleholder Use</i> .....	52
<i>Placing the Needle in Tissue</i> .....	53
<b>Needle Handling Tips</b> .....	53

---

## 4 PACKAGING

---

<b>An Integral Part of the Product</b> .....	56
<b>RELAY* Suture Delivery System</b> .....	56
<i>Modular Storage Racks</i> .....	56
<i>Dispenser Boxes</i> .....	57
<i>Primary Packets</i> .....	57
<b>E-PACK* Procedure Kit</b> .....	59
<b>Expiration Date</b> .....	60
<b>Suture Sterilization</b> .....	60
<b>Anticipating Suture Needs</b> .....	61
<i>Sterile Transfer of Suture Packets</i> .....	61
<i>Suture Preparation in the Sterile Field</i> .....	62
<i>Suture Handling Technique</i> .....	63

---

## 5 TOPICAL SKIN ADHESIVES

---

<b>DERMABOND* Topical Skin Adhesive</b> .....	68
---	----

---

## 6 OTHER SURGICAL PRODUCTS

---

<b>Adhesive Tapes</b> .....	74
<i>Indications and Usage</i> .....	74
<i>Application</i> .....	74
<i>After Care and Removal</i> .....	74
<i>Skin Closure Tapes</i> .....	75
<i>Polyester Fiber Strip</i> .....	75
<i>Umbilical Tape</i> .....	75
<b>Surgical Staples</b> .....	75
<i>Indications and Usage</i> .....	76
<i>Aftercare and Removal</i> .....	76
<i>PROXIMATE* Skin Staplers</i> .....	76
<b>Looped Suture</b> .....	77
<b>Retention Suture Devices</b> .....	77

---

## 7 PRODUCT TERMS AND TRADEMARKS

---

---

## 8 PRODUCT INFORMATION

---

---

## 9 INDEX

---

# WOUND HEALING AND MANAGEMENT



## THE WOUND

Injury to any of the tissues of the body, especially that caused by physical means and with interruption of continuity is defined as a *wound*.<sup>1</sup> Though most often the result of a physical cause, a burn is also considered a wound. Both follow the same processes towards the restoration to health – otherwise known as *healing*.<sup>1</sup>

Wound healing is a natural and spontaneous phenomenon. When tissue has been disrupted so severely that it cannot heal naturally (without complications or possible disfigurement) dead tissue and foreign bodies must be removed, infection treated, and the tissue must be held in apposition until the healing process provides the wound with sufficient strength to withstand stress without mechanical support. A wound may be approximated with sutures, staples, clips, skin closure strips, or topical adhesives.

*Tissue* is defined as a collection of similar cells and the intercellular substances surrounding them. There are four basic tissues in the body: 1) epithelium; 2) connective tissues, including blood, bone and cartilage; 3) muscle tissue; and 4) nerve tissue. The choice of wound closure materials and the techniques of using them are prime factors in the restoration of continuity and tensile strength to the injured tissues during the healing process.

The parameters for measuring the strength of normal body tissue are:

- **Tensile Strength**—The load per cross-sectional area unit at the

point of rupture, relating to the nature of the material rather than its thickness.

- **Breaking Strength**—The load required to break a wound regardless of its dimension, the more clinically significant measurement.
- **Burst Strength**—The amount of pressure needed to rupture a viscus, or large interior organ.

The rate at which wounds regain strength during the wound healing process must be understood as a basis for selecting the most appropriate wound closure material.

## RECOVERY OF TENSILE STRENGTH

Tensile strength affects the tissue's ability to withstand injury but is not related to the length of time it takes the tissue to heal. As collagen accumulates during the reparative phase, strength increases rapidly but it is many months before a plateau is reached.<sup>2</sup> Until this time, the wound requires extrinsic support from the method used to bring it together – usually sutures. While skin and fascia (the layer of firm connective tissue covering muscle) are the strongest tissues in the body, they regain tensile strength slowly during the healing process. The stomach and small intestine, on the other hand, are composed of much weaker tissue but heal rapidly. Variations in tissue strength may also be found within the same organ. Within the colon, for example, the sigmoid region is approximately twice as strong as the cecum—but both sections heal at the same rate. Factors that affect tissue strength include the size, age, and weight of the patient, the

thickness of tissue, the presence of edema, and duration (the degree to which the tissue has hardened in response to pressure or injury).

## PATIENT FACTORS THAT AFFECT WOUND HEALING

The goal of wound management is to provide interventions that efficiently progress wounds through the biologic sequence of repair or regeneration. The patient's overall health status will affect the speed of the healing process. The following are factors that should be considered by the surgical team prior to and during the procedure.<sup>2,3,4</sup>

- ◆ **AGE** — With aging, both skin and muscle tissue lose their tone and elasticity. Metabolism also slows, and circulation may be impaired. But aging alone is not a major factor in chronic wound healing. Aging and chronic disease states often go together, and both delay repair processes due to delayed cellular response to the stimulus of injury, delayed collagen deposition, and decreased tensile strength in the remodeled tissue. All of these factors lengthen healing time.
- ◆ **WEIGHT** — Obese patients of any age have, excess fat at the wound site that may prevent securing a good closure. In addition, fat does not have a rich blood supply, making it the most vulnerable of all tissues to trauma and infection.
- ◆ **NUTRITIONAL STATUS** — Overall malnutrition associated with chronic disease or cancer, or specific deficiencies in



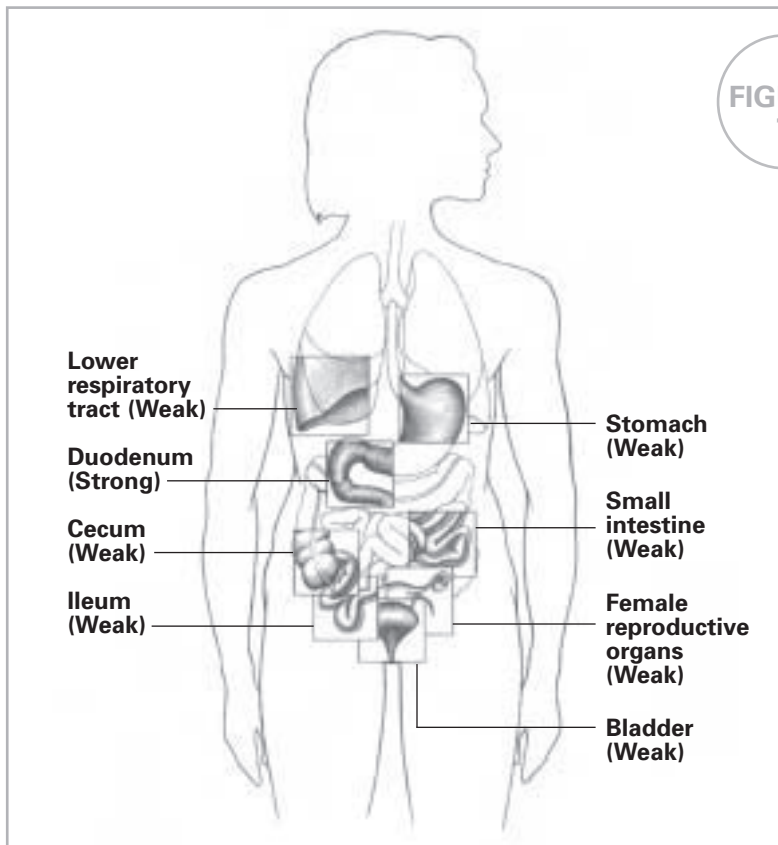

carbohydrates, proteins, zinc, and vitamins A, B, and C can impair the healing process. Adequate nutrition is essential to support cellular activity and collagen synthesis at the wound site.

◆ **DEHYDRATION** — If the patient's system has been depleted of fluids, the resulting electrolyte imbalance can affect cardiac function, kidney function, cellular metabolism, oxygenation of the blood, and hormonal function. These effects will not only impact upon the patient's overall health status and recovery from surgery but may also impair the healing process.

◆ **INADEQUATE BLOOD SUPPLY TO THE WOUND SITE** — Oxygen is necessary for cell survival and, therefore,

healing. Skin healing takes place most rapidly in the face and neck, which receive the greatest blood supply, and most slowly in the extremities. The presence of any condition that compromises the supply of blood to the wound, such as poor circulation to the limbs in a diabetic patient or arteriosclerosis with vascular compromise, will slow and can even arrest the healing process.

◆ **IMMUNE RESPONSES** — Because the immune response protects the patient from infection, immunodeficiencies may seriously compromise the outcome of a surgical procedure. Patients infected with HIV, as well as those who have recently undergone chemotherapy or who have taken prolonged high dosages of catabolic steroids, may

have debilitated immune systems. Some patients have allergies to specific suturing materials, metal alloys, or latex. These, on the other hand, will cause a heightened immune response in the form of an allergic reaction. This may also interfere with the healing process. Therefore, the surgeon should always check beforehand on a patient's allergies.

◆ **CHRONIC DISEASE** — A patient whose system has already been stressed by chronic illness, especially endocrine disorders, diabetes, malignancies, localized infection, or debilitating injuries will heal more slowly and will be more vulnerable to post surgical wound complications. All of these conditions merit concern, and the surgeon must consider their effects upon the tissues at the wound site, as well as their potential impact upon the patient's overall recovery from the procedure. Malignancies, in addition, may alter the cellular structure of tissue and influence the surgeon's choice of methods and closure materials.

◆ **RADIATION THERAPY** — Radiation therapy to the surgical site prior to or shortly after surgery can produce considerable impairment of healing and lead to substantial wound complications. Surgical procedures for malignancies must be planned to minimize the potential for these problems.



## SURGICAL PRINCIPLES

Many factors that affect the healing process can be controlled by the surgical team in the operating room, by the obstetrical team in labor and delivery, or by the emergency team in the trauma center. Their first priority is to maintain a sterile and aseptic technique to prevent infection. Organisms found within a patient's own body most commonly cause postoperative infection, but microorganisms carried by medical personnel also pose a threat. Whatever the source, the presence of infection will deter healing. In addition to concerns about sterility, the following must be taken into consideration when planning and carrying out an operative procedure.<sup>3</sup>

◆ **THE LENGTH AND DIRECTION OF THE INCISION** — A properly planned incision is sufficiently long to afford sufficient optimum exposure. When deciding upon the direction of the incision, the surgeon must bear the following in mind:

- The direction in which wounds naturally heal is from side-to-side, not end-to-end.
- The arrangement of tissue fibers in the area to be dissected will vary with tissue type.
- The best cosmetic results may be achieved when incisions are made parallel to the direction of the tissue fibers. Results may vary depending upon the tissue layer involved.

◆ **DISSECTION TECHNIQUE** — When incising tissue, a clean incision should be made through the skin with one stroke of evenly applied pressure on the scalpel. Sharp dissection should be used to cut through remaining tissues. The surgeon must preserve the integrity of as many of the underlying nerves, blood vessels, and muscles as possible.

◆ **TISSUE HANDLING** — Keeping tissue trauma to a minimum promotes faster healing. Throughout the operative procedure, the surgeon must handle all tissues very gently and as little as possible. Retractors should be placed with care to avoid excessive pressure, since tension can cause serious complications: impaired blood and lymph flow, altering of the local physiological state of the wound, and predisposition to microbial colonization.

◆ **HEMOSTASIS** — Various mechanical, thermal, and chemical methods are available to decrease the flow of blood and fluid into the wound site. Hemostasis allows the surgeon to work in as clear a field as possible with greater accuracy. Without adequate control, bleeding from transected or penetrated vessels or diffused oozing on large denuded surfaces may interfere with the surgeon's view of underlying structures.

Achieving complete hemostasis before wound closure also will prevent formation of postoperative hematomas. Collections of

blood (hematomas) or fluid (seromas) in the incision can prevent the direct apposition of tissue needed for complete union of wound edges. Furthermore, these collections provide an ideal culture medium for microbial growth and can lead to serious infection.

When clamping or ligating a vessel or tissue, care must be taken to avoid excessive tissue damage. Mass ligation that involves large areas of tissue may produce necrosis, or tissue death, and prolong healing time.

◆ **MAINTAINING MOISTURE IN TISSUES** — During long procedures, the surgeon may periodically irrigate the wound with warm physiologic (normal) saline solution, or cover exposed surfaces with saline-moistened sponges or laparotomy tapes to prevent tissues from drying out.

◆ **REMOVAL OF NECROTIC TISSUE AND FOREIGN MATERIALS** — Adequate debridement of all devitalized tissue and removal of inflicted foreign materials are essential to healing, especially in traumatic wounds. The presence of fragments of dirt, metal, glass, etc., increases the probability of infection.

◆ **CHOICE OF CLOSURE MATERIALS** — The surgeon must evaluate each case individually, and choose closure material which will maximize the opportunity for healing and minimize the likelihood of infection. The proper closure

material will allow the surgeon to approximate tissue with as little trauma as possible, and with enough precision to eliminate dead space. The surgeon's personal preference will play a large role in the choice of closure material; but the location of the wound, the arrangement of tissue fibers, and patient factors influence his or her decision as well.

### CELLULAR RESPONSE TO CLOSURE MATERIALS —

Whenever foreign materials such as sutures are implanted in tissue, the tissue reacts. This reaction will range from minimal to moderate, depending upon the type of material implanted. The reaction will be more marked if complicated by infection, allergy, or trauma.

Initially, the tissue will deflect the passage of the surgeon's needle and suture. Once the sutures have been implanted, edema of the skin and subcutaneous tissues will ensue. This can cause significant patient discomfort during recovery, as well as scarring secondary to ischemic necrosis. The surgeon must take these factors into consideration when placing tension upon the closure material.

### ELIMINATION OF DEAD SPACE IN THE WOUND —

Dead space in a wound results from separation of portions of the wound beneath the skin edges which have not been closely approximated, or from air or fluid trapped between layers of tissue. This is especially true in the fatty layer which tends to lack

blood supply. Serum or blood may collect, providing an ideal medium for the growth of microorganisms that cause infection. The surgeon may elect to insert a drain or apply a pressure dressing to help eliminate dead space in the wound postoperatively.

#### ◆ CLOSING TENSION —

While enough tension must be applied to approximate tissue and eliminate dead space, the sutures must be loose enough to prevent exaggerated patient discomfort, ischemia, and tissue necrosis during healing.

#### ◆ POSTOPERATIVE DISTRACTION FORCES —

The patient's postoperative activity can place undue stress upon a healing incision. Abdominal fascia will be placed under excessive tension after surgery if the patient strains to cough, vomit, void, or defecate.

Tendons and the extremities may also be subjected to excessive tension during healing. The surgeon must be certain that the approximated wound is adequately immobilized to prevent suture disruption for a sufficient period of time after surgery.

#### ◆ IMMOBILIZATION —

Adequate immobilization of the approximated wound, but not necessarily of the entire anatomic part, is mandatory after surgery for efficient healing and minimal scar formation.

## CLASSIFICATION OF WOUNDS

The Centers for Disease Control and Prevention (CDC), using an adaptation of the American College of Surgeons' wound classification schema, divides surgical wounds into four classes: clean wounds, clean-contaminated wounds,

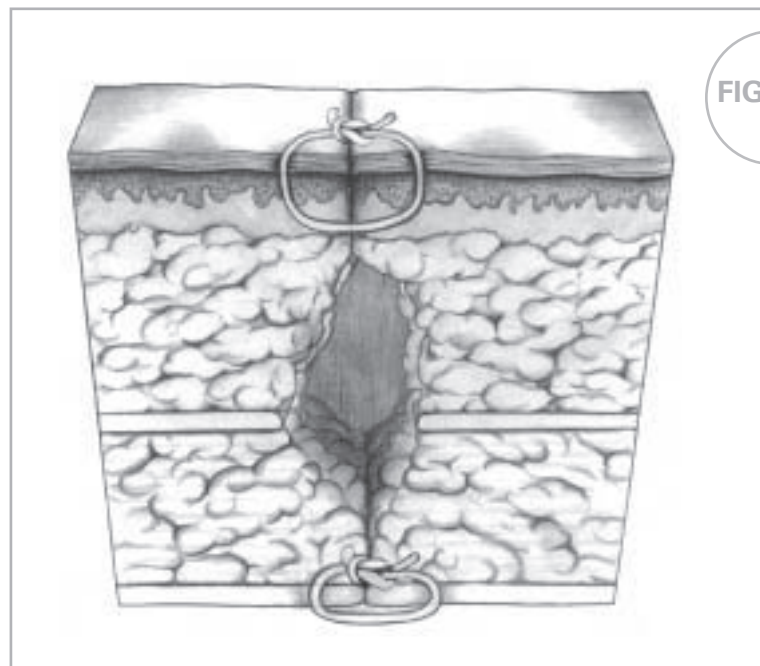

FIGURE 2

DEAD SPACE IN A WOUND

contaminated wounds and dirty or infected wounds.<sup>5</sup> A discussion of each follows.

Seventy-five percent of all wounds (which are usually elective surgical incisions) fall into the *clean wounds* category—an uninfected operative wound in which no inflammation is encountered and the respiratory, alimentary, genital, or uninfected urinary tracts are not entered. These elective incisions are made under aseptic conditions and are not predisposed to infection. Inflammation is a natural part of the healing process and should be differentiated from infection in which bacteria are present and produce damage.

Clean wounds are closed by primary union and usually are not drained. Primary union is the most desirable method of closure, involving the simplest surgical procedures and the lowest risk of postoperative complications. Apposition of tissue is maintained until wound tensile strength is sufficient so that sutures or other forms of tissue apposition are no longer needed.

*Clean-contaminated wounds* are operative wounds in which the respiratory, alimentary, genital, or urinary tracts are entered under controlled conditions and without unusual contamination. Specifically, operations involving the biliary tract, appendix, vagina, and oropharynx are included in this category provided no evidence of infection or major break in technique is encountered. Appendectomies, cholecystectomies, and hysterectomies fall into this category, as well as normally clean wounds which become

contaminated by entry into a viscus resulting in minimal spillage of contents.

*Contaminated wounds* include open, traumatic wounds or injuries such as soft tissue lacerations, open fractures, and penetrating wounds; operative procedures in which gross spillage from the gastrointestinal tract occurs; genitourinary or biliary tract procedures in the presence of infected urine or bile; and operations in which a major break in aseptic technique has occurred (as in emergency open cardiac massage). Microorganisms multiply so rapidly that within 6 hours a contaminated wound can become infected.

*Dirty and infected wounds* have been heavily contaminated or clinically infected prior to the operation. They include perforated viscera, abscesses, or neglected traumatic wounds in which devitalized tissue or foreign material have been retained. Infection present at the time of surgery can increase the infection rate of any wound by an average of four times.

## TYPES OF WOUND HEALING

The rate and pattern of healing falls into three categories, depending upon the type of tissue involved and the circumstances surrounding closure. Timeframes are generalized for well-perfused healthy soft tissues, but may vary.

### HEALING BY PRIMARY INTENTION

Every surgeon who closes a wound would like it to heal by primary union or first intention, with minimal edema and no local infection or serious discharge. An incision that heals by primary intention does so in a minimum of time, with no separation of the wound edges, and with minimal scar formation. This takes place in three distinct phases:<sup>2,3</sup>

*Inflammatory* (preparative) – During the first few days, an inflammatory response causes an outpouring of tissue fluids, an accumulation of cells and fibroblasts, and an increased blood supply to the wound. Leukocytes and other cells produce proteolytic enzymes which dissolve and remove damaged tissue debris. These are the responses which prepare the site of injury for repair. The process lasts 3 to 7 days. Any factor which interferes with the progress, may interrupt or delay healing. During the acute inflammatory phase, the tissue does not gain appreciable tensile strength, but depends solely upon the closure material to hold it in approximation.

*Proliferative* – After the debridement process is well along, fibroblasts begin to form a collagen matrix in the wound known as granulation tissue. Collagen, a protein substance, is the chief constituent of connective tissue. Collagen fiber formation determines the tensile strength and pliability of the healing wound. As it fills with new blood vessels, the granulation becomes bright, beefy, red tissue. The thick capillary bed which fills

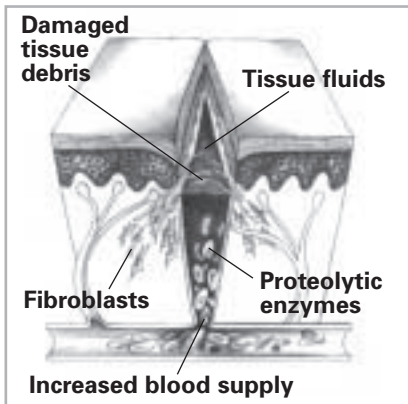
**PHASE 1–**

Inflammatory response and debridement process

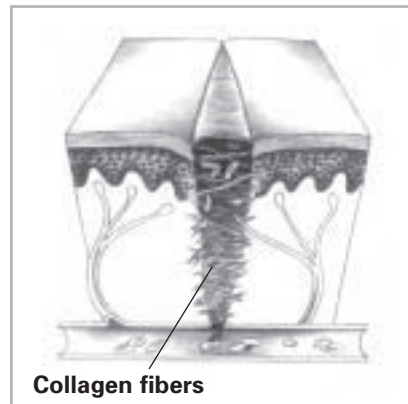
**PHASE 2–**

Collagen formation (scar tissue)

**PHASE 3–**

Sufficient collagen laid down

FIGURE 3

**PHASES OF WOUND HEALING**

the matrix, supplies the nutrients and oxygen necessary for the wound to heal. This phase occurs from day 3 onward.

In time, sufficient collagen is laid down across the wound so that it can withstand normal stress. The length of this phase varies with the type of tissue involved and the stresses or tension placed upon the wound during this period.

Wound contraction also occurs during this phase. Wound contraction is a process that pulls the wound edges together for the purpose of closing the wound. In essence, it reduces the open area, and if successful, will result in a smaller wound with less need for repair by scar formation. Wound contraction can be very beneficial in the closure of wounds in areas such as the buttocks or trochanter but can be very harmful in areas such as the hand or around the neck and face, where it can cause disfigurement and excessive scarring.<sup>3</sup>

Surgical wounds that are closed by primary intention have minimal contraction response. Skin grafting is used to reduce avoided contraction in undesirable locations.

*Remodelling* – As collagen deposition is completed, the vascularity of the wound gradually decreases and any surface scar becomes paler. The amount of collagen that is finally formed – the ultimate scar – is dependent upon the initial volume of granulation tissue.<sup>2</sup>

### HEALING BY SECOND INTENTION

When the wound fails to heal by primary union, a more complicated and prolonged healing process takes place. Healing by second intention is caused by infection, excessive trauma, tissue loss, or imprecise approximation of tissue.<sup>3</sup>

In this case, the wound may be left open and allowed to heal from the inner layer to the outer surface. Granulation tissue forms and contains myofibroblasts. These specialized cells help to close the wound by contraction. This process is much slower than primary intention healing. Excessive granulation tissue may build up and require treatment if it protrudes above the surface of the wound, preventing epithelialization.

### DELAYED PRIMARY CLOSURE

This is considered by many surgeons to be a safe method of management of contaminated, as well as dirty and infected traumatic wounds with extensive tissue loss and a high risk of infection. This method has been used extensively in the military arena and has proven successful following excessive trauma related to motor vehicle accidents, shooting incidents, or infliction of deep, penetrating knife wounds.<sup>3</sup>

The surgeon usually treats these injuries by debridement of nonviable tissues and leaves the wound open, inserting gauze packing which is changed twice a day. Patients sedation or a return to the operating room with general anesthesia generally is only required in the case of large, complex wounds. Wound approximation using adhesive strips, previously placed but untied sutures, staples after achieving local anesthesia can occur within 3-5 days if the wound demonstrates no evidence of infection and the appearance of red granulation tissue. Should this not



occur, the wound is allowed to heal by secondary intention. When closure is undertaken, skin edges and underlying tissue must be accurately and securely approximated.

## IN THE NEXT SECTION

The materials, devices, and techniques used to repair wounded tissue will be discussed at length. As you will see, the number of options available is extensive. But no matter how many choices the surgeon has, his or her objective remains singular: to restore the patient to health with as little operative trauma as possible and an excellent cosmetic result.

## REFERENCES

1. *Stedman's Medical Dictionary*, 27th edition, 2000
2. Henry, Michael and Thompson, Jeremy: *Clinical Surgery*, W.B. Saunders, 2001
3. Skerris, David A.: *Mayo Clinic Basic Surgery Skills*, Mayo Clinic Scientific Press, 1999
4. Sussman, Carrie: *Wound Care*, Aspen Publishers, 1998
5. *NNIS Manual*, CDC, MHA, 2000

# THE SUTURE

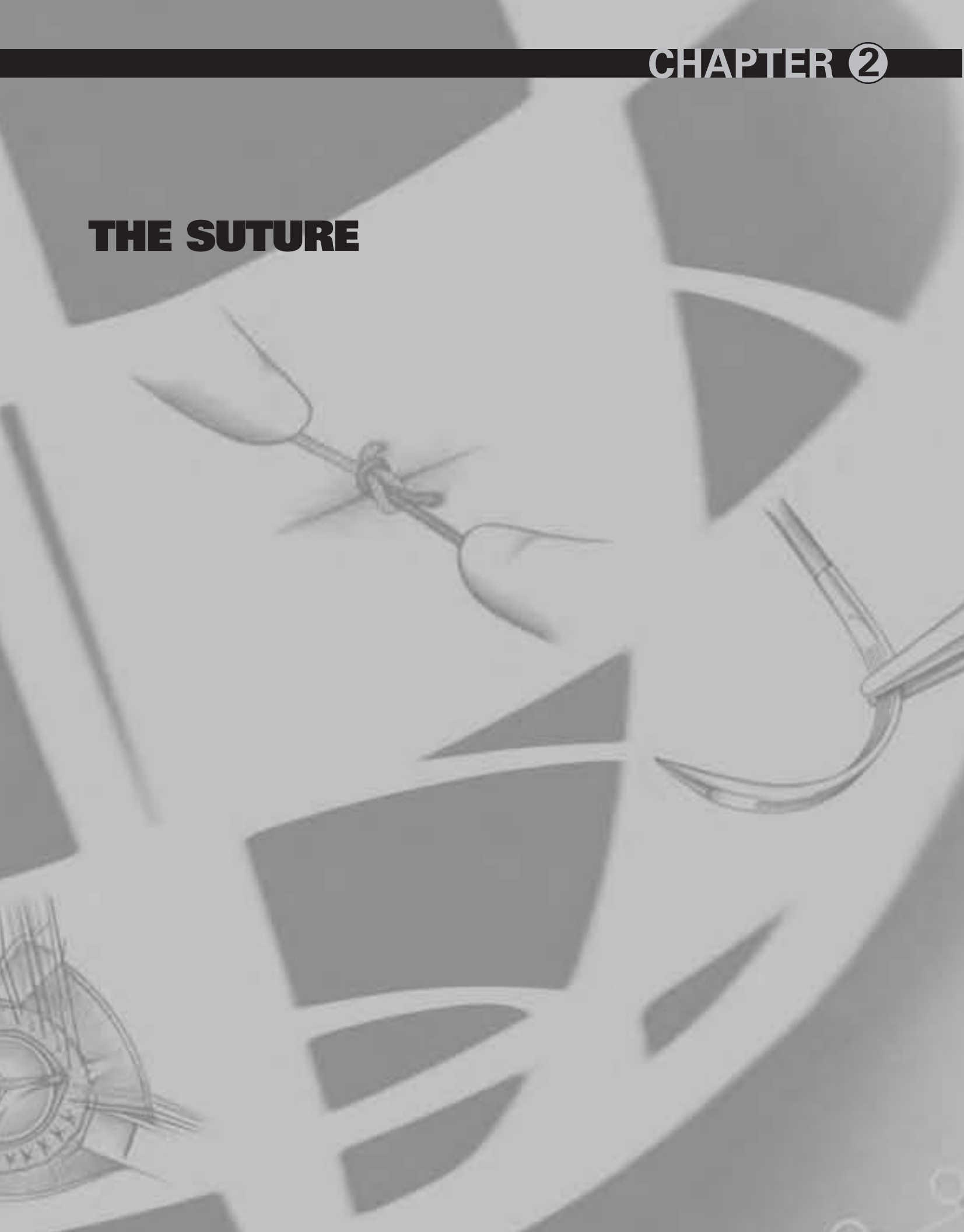



## WHAT IS A SUTURE?

The word "suture" describes any strand of material used to ligate (tie) blood vessels or approximate (bring close together) tissues. *Sutures* are used to close wounds. Sutures and ligatures were used by both the Egyptians and Syrians as far back as 2,000 B.C. Through the centuries, a wide variety of materials—silk, linen, cotton, horsehair, animal tendons and intestines, and wire made of precious metals—have been used in operative procedures. Some of these are still in use today.

The evolution of suturing material has brought us to a point of refinement that includes sutures designed for specific surgical procedures.

Despite the sophistication of today's suture materials and surgical techniques, closing a wound still involves the same basic procedure used by physicians to the Roman emperors. The surgeon still uses a surgical needle to penetrate tissue and advance a suture strand to its desired location.

Successful use of suture materials depends upon the cooperation of the suture manufacturer and the surgical team.

The *manufacturer* must have a thorough knowledge of surgical procedures, anticipate the surgical team's needs, and produce suture materials that meet these stringent criteria:

- They must have the greatest tensile strength consistent with size limitations.
- They must be easy to handle.

- They must be secured in packaging which presents them sterile for use, in excellent condition, and ensures the safety of each member of the surgical team.

The *nurse* must maintain the sterility of sutures when storing, handling, and preparing them for use. The integrity and strength of each strand must remain intact until it is in the surgeon's hands.

The *surgeon* must select suture materials appropriate for the procedure and must place them in the tissues in a manner consistent with the principles that promote wound healing.

With the manufacturer and surgical team working in concert, the patient reaps the final benefit...*the wound is closed in a manner that promotes optimum healing in minimum time.*

## PERSONAL SUTURE PREFERENCE

Most surgeons have a basic "suture routine," a preference for using the same material(s) unless circumstances dictate otherwise. The surgeon acquires skill, proficiency, and speed in handling by using one suture material repeatedly—and may choose the same material throughout his or her entire career.

A number of factors may influence the surgeon's choice of materials:

- His or her area of specialization.
- Wound closure experience during clinical training.
- Professional experience in the operating room.
- Knowledge of the healing characteristics of tissues and organs.
- Knowledge of the physical and biological characteristics of various suture materials.
- Patient factors (age, weight, overall health status, and the presence of infection).

Surgical specialty plays a primary role in determining suture preference. For example, obstetrician/gynecologists frequently prefer coated VICRYL\* *RAPIDE* (polyglactin 910) suture for episiotomy repair and coated VICRYL\* (polyglactin 910) suture, coated VICRYL\* *Plus* Antibacterial (polyglactin 910) suture and MONOCRYL\* (poliglecaprone 25) suture for all tissue layers except, possibly skin. Most orthopaedic surgeons use coated VICRYL suture, coated VICRYL *Plus*, PDS\* II (polydioxanone) suture, and ETHIBOND\* *EXCEL* polyester suture. Many plastic surgeons prefer ETHILON\* nylon suture, VICRYL suture, or MONOCRYL suture. Many neurosurgeons prefer coated VICRYL suture or NUROLON\* nylon suture. *But no single suture material is used by every surgeon who practices within a specialty.*

The surgeon's knowledge of the physical characteristics of suture material is important. As the requirements for wound support vary with patient factors, the nature of the

procedure, and the type of tissue involved, the surgeon will select suture material that will retain its strength until the wound heals sufficiently to withstand stress on its own.

## SUTURE CHARACTERISTICS

The choice of suture materials generally depends on whether the wound closure occurs in one or more layers. In selecting the most appropriate sutures, the surgeon takes into account the amount of tension on the wound, the number of layers of closure, depth of suture placement, anticipated amount of edema, and anticipated timing of suture removal.

Optimal suture qualities include:

1. High uniform tensile strength, permitting use of finer sizes.
2. High tensile strength retention *in vivo*, holding the wound securely throughout the critical healing period, followed by rapid absorption.
3. Consistent uniform diameter.
4. Sterile.
5. Pliable for ease of handling and knot security.
6. Freedom from irritating substances or impurities for optimum tissue acceptance.
7. Predictable performance.

## SIZE AND TENSILE STRENGTH

*Size* denotes the diameter of the suture material. The accepted surgical practice is to use the smallest diameter suture that will adequately hold the mending wounded tissue. This practice minimizes trauma as the suture is passed through the tissue to effect closure. It also ensures that the minimum mass of foreign material is left in the body. Suture size is stated numerically; as the number of 0s in the suture size increases, the diameter of the strand decreases. For example, size 5-0, or 00000, is smaller in diameter than size 4-0, or 0000. The smaller the size, the less tensile strength the suture will have.

*Knot tensile strength* is measured by the force, in pounds, which the suture strand can withstand before it breaks when knotted. The tensile strength of the tissue to be mended (its ability to withstand stress) determines the size and tensile strength of the suturing material the surgeon selects. The accepted rule is that the tensile strength of the suture need never exceed the tensile strength of the tissue. However, sutures should be at least as strong as normal tissue through which they are being placed.

## MONOFILAMENT VS. MULTIFILAMENT STRANDS

Sutures are classified according to the number of strands of which they are comprised. *Monofilament sutures* are made of a single strand of material. Because of their simplified structure, they encounter less resistance as they pass through tissue than multifilament suture material. They also resist harboring organisms which may cause infection.

These characteristics make monofilament sutures well-suited to vascular surgery. Monofilament sutures tie down easily. However, because of their construction, extreme care must be taken when handling and tying these sutures. Crushing or crimping of this suture type can nick or create a weak spot in the strand. This may result in suture breakage.

*Multifilament sutures* consist of several filaments, or strands, twisted or braided together. This affords greater tensile strength, pliability, and flexibility. Multifilament sutures may also be coated to help them pass relatively smoothly through tissue and enhance handling characteristics. Coated multifilament sutures are well-suited to intestinal procedures.

## METRIC MEASURES AND U.S.P. SUTURE DIAMETER EQUIVALENTS

TABLE 1

U.S.P. Size	11-0	10-0	9-0	8-0	7-0	6-0	5-0	4-0	3-0	2-0	0	1	2	3	4	5	6
Natural Collagen	—	0.2	0.3	0.5	0.7	1.0	1.5	2.0	3.0	3.5	4.0	5.0	6.0	7.0	8.0	—	—
Synthetic Absorbables	—	0.2	0.3	0.4	0.5	0.7	1.0	1.5	2.0	3.0	3.5	4.0	5.0	6.0	6.0	7.0	—
Nonabsorbable Materials	0.1	0.2	0.3	0.4	0.5	0.7	1.0	1.5	2.0	3.0	3.5	4.0	5.0	6.0	6.0	7.0	8.0

\* Trademark

## ABSORBABLE VS. NONABSORBABLE SUTURES

Sutures are classified according to their degradation properties. Sutures that undergo rapid degradation in tissues, losing their tensile strength within 60 days, are considered *absorbable* sutures. Sutures that generally maintain their tensile strength for longer than 60 days are *nonabsorbable* sutures.

**Absorbable sutures** may be used to hold wound edges in approximation temporarily, until they have healed sufficiently to withstand normal stress. These sutures are prepared either from the collagen of healthy mammals or from synthetic polymers. Some are absorbed rapidly, while others are treated or chemically structured to lengthen absorption time. They may also be impregnated or coated with agents that improve their handling properties, and colored with an FDA-approved dye to increase visibility in tissue. Natural absorbable sutures are digested by body enzymes which attack and break down the suture strand. Synthetic absorbable sutures are hydrolyzed—a process by which water gradually penetrates the suture filaments, causing the breakdown of the suture's polymer chain. Compared to the enzymatic action of natural absorbables, hydrolyzation results in a lesser degree of tissue reaction following implantation.

During the first stage of the absorption process, tensile strength diminishes in a gradual, almost linear fashion. This occurs over the first several weeks postimplantation. The second stage often follows with

SUTURE	RAW MATERIAL
Surgical Gut Plain Chromic Fast Absorbing	Submucosa of sheep intestine or serosa of beef intestine
Polyglactin 910 Uncoated (VICRYL Suture)  Coated (coated VICRYL (polyglactin 910) suture, coated VICRYL <i>Plus</i> suture, coated VICRYL* <i>RAPIDE</i> (polyglactin 910) suture)	Copolymer of glycolide and lactide with polyglactin 370 and calcium stearate, if coated
Polyglycolic Acid	Homopolymer of glycolide
Poliglecaprone 25 (MONOCRYL suture)	Copolymer of glycolide and epsilon-caprolactone
Polyglyconate	Copolymer of glycolide and trimethylene carbonate
Polydioxanone (PDS* II suture)	Polyester of poly (p-dioxanone)

TABLE 2

### ABSORBABLE SUTURES: BASIC RAW MATERIALS

considerable overlap, characterized by loss of suture mass. Both stages exhibit leukocytic cellular responses which serve to remove cellular debris and suture material from the line of tissue approximation.

The loss of tensile strength and the rate of absorption are separate phenomena. A suture can lose tensile strength rapidly and yet be absorbed slowly—or it can maintain adequate tensile strength through wound healing, followed by rapid absorption. In any case, the strand is eventually completely dissolved, leaving no detectable traces in tissue.

Although they offer many advantages, absorbable sutures also have certain inherent limitations. If a patient has a fever, infection, or protein deficiency, the suture absorption process may accelerate,

causing too rapid a decline in tensile strength. In addition, if the sutures become wet or moist during handling, prior to being implanted in tissue, the absorption process may begin prematurely. Similarly, patients with impaired healing are often not ideal candidates for this type of suture. All of these situations predispose to postoperative complications, as the suture strand will not maintain adequate strength to withstand stress until the tissues have healed sufficiently.

**Nonabsorbable sutures** are those which are not digested by body enzymes or hydrolyzed in body tissue. They are made from a variety of nonbiodegradable materials and are ultimately encapsulated or walled off by the body's fibroblasts. Nonabsorbable sutures ordinarily remain where they are buried

within the tissues. When used for skin closure, they must be removed postoperatively. Nonabsorbable sutures may be used in a variety of applications:

- Exterior skin closure, to be removed after sufficient healing has occurred.
- Within the body cavity, where they will remain permanently encapsulated in tissue.
- Patient history of reaction to absorbable sutures, keloidal tendency, or possible tissue hypertrophy.
- Prosthesis attachment (i.e., defibrillators, pacemakers, drug delivery mechanisms).

Nonabsorbable sutures are composed of single or multiple filaments of metal, synthetic, or organic fibers rendered into a strand by spinning, twisting, or braiding. Each strand is substantially uniform in diameter throughout its length, conforming to the United States Pharmacopeia (U.S.P.) limitations for each size. Nonabsorbable sutures have been classified by the U.S.P. according to their composition. In addition, these sutures may be uncoated or coated, uncolored, naturally colored, or dyed with an FDA-approved dye to enhance visibility.

### SPECIFIC SUTURING MATERIALS

The materials and products described here embody the most current advances in the manufacture of surgical sutures. They are grouped as either *absorbable* or *nonabsorbable* for easy reference.

SUTURE	RAW MATERIAL
Surgical Silk	Raw silk spun by silkworm
Stainless Steel Wire	Specially formulated iron-chromium-nickel-molybdenum alloy
Nylon (ETHILON* nylon suture, NUROLON* nylon suture)	Polyamide polymer
Polyester Fiber Uncoated (MERSILENE* polyester fiber suture) Coated (ETHIBOND* EXCEL polyester suture)	Polymer of polyethylene terephthalate (may be coated)
Polypropylene (PROLENE* polypropylene suture)	Polymer of propylene
Poly(hexafluoropropylene-VDF) (PRONOVA* poly(hexafluoropropylene-VDF) suture)	Polymer blend of poly(vinylidene fluoride) and poly(vinylidene fluoride-cohexafluoropropylene)

TABLE 3

**NON-ABSORBABLE SUTURES: RAW MATERIALS**

### Absorbable Sutures Surgical Gut

Absorbable surgical gut is classified as either *plain* or *chromic*. Both types consist of processed strands of highly purified collagen. The percentage of collagen in the suture determines its tensile strength and its ability to be absorbed by the body without adverse reaction. Noncollagenous material can cause a reaction ranging from irritation to rejection of the suture. The more pure collagen throughout the length of the strand, the less foreign material there is introduced into the wound.

ETHICON\* surgical gut sutures are manufactured from between 97% and 98% pure ribbons of collagen. To meet U.S.P. specifications, processed ribbons of the submucosa layer of sheep intestine or the serosa layer of beef intestine are electronically spun and polished into virtually monofilament strands of various sizes, with minimum and

maximum limits on diameter for each size. The ETHICON exclusive TRU-GAUGING process produces a uniform diameter to within an accuracy of 0.0002 inch (0.0175mm) along the entire length of every strand, eliminating high and low spots. High and low spots can cause the suture to fray or chatter when knots are tied down, resulting in a knot that is not positioned properly or tied securely. Most protein-based absorbable sutures have a tendency to fray when tied.

TRU-GAUGING ensures that ETHICON surgical gut sutures possess uniform high tensile strength, virtually eliminating the possibility of fray or breaking. Their unexceeded strength and surface smoothness allow the surgeon to "snug down" the suture knot to achieve optimum tension.

The rate of absorption of surgical gut is determined by the type of

\* Trademark



gut being used, the type and condition of the tissue involved, and the general health status of the patient. Surgical gut may be used in the presence of infection, although it may be absorbed more rapidly under this condition.

*Plain surgical gut* is rapidly absorbed. Tensile strength is maintained for only 7 to 10 days postimplantation, and absorption is complete within 70 days. The surgeon may choose plain gut for use in tissues which heal rapidly and require minimal support (for example, ligating superficial blood vessels and suturing subcutaneous fatty tissue). Plain surgical gut can also be specially heat-treated to accelerate tensile strength loss and absorption. This fast absorbing surgical gut is used primarily for epidermal suturing where sutures are required for only 5 to 7 days. These sutures have less tensile strength than plain surgical gut of the comparable U.S.P. size. Fast absorbing plain gut is not to be used internally.

*Chromic gut* is treated with a chromium salt solution to resist body enzymes, prolonging absorption time over 90 days. The exclusive CHROMICIZING process used by ETHICON thoroughly bathes the pure collagen ribbons in a buffered chrome tanning solution before spinning into strands. After spinning, the entire cross section of the strand is evenly chromicized. The process alters the coloration of the surgical gut from yellowish-tan to brown. Chromic gut sutures minimize tissue irritation, causing less reaction than plain surgical gut

during the early stages of wound healing. Tensile strength may be retained for 10 to 14 days, with some measurable strength remaining for up to 21 days.

### **SYNTHETIC ABSORBABLE SUTURES**

*Synthetic absorbable sutures* offer the strength needed for a wide range of applications, from abdominal and chest wound closure to ophthalmic and plastic surgery.

#### **COATED VICRYL\* RAPIDE (POLYGLACTIN 910) SUTURE**

This braided suture is composed of the same copolymer as coated VICRYL suture—lactide and glycolide—and is coated with a combination of equal parts of copolymer of lactide and glycolide (polyglactin 370) and calcium stearate. However, the absorption rate and tensile strength profile are significantly different from coated VICRYL suture, achieved by the use of a polymer material with a lower molecular weight than coated VICRYL suture. Coated VICRYL *RAPIDE* sutures are only available undyed.

Coated VICRYL *RAPIDE* suture is the fastest-absorbing synthetic suture and exhibits characteristics that model the performance of surgical gut suture. However, being a synthetic material. Coated VICRYL *RAPIDE* suture elicits a lower tissue reaction than chromic gut suture. Coated VICRYL *RAPIDE* suture is indicated only for use in superficial soft tissue approximation of the skin and mucosa, where only short-term wound support (7 to 10 days) is required. It is not to be used in

ligation, in ophthalmic, cardiovascular, or neurological procedures, where extended approximation of tissues under stress is required, or where wound support beyond 7 days is required.

Coated VICRYL *RAPIDE* sutures retain approximately 50% of the original tensile strength at 5 days postimplantation. All of the original tensile strength is lost by approximately 10 to 14 days. Absorption is essentially complete by 42 days.

Coated VICRYL *RAPIDE* suture is particularly well-suited for skin closure, episiotomy repair, and closure of lacerations under casts. In addition, since the suture begins to "fall off" in 7 to 10 days as the wound heals, the need for suture removal is eliminated.

#### **MONOCRYL\* (POLIGLECAPRONE 25) SUTURE**

This monofilament suture features superior pliability for easy handling and tying. Comprised of a copolymer of glycolide and epsilon-caprolactone, it is virtually inert in tissue and absorbs predictably. The surgeon may prefer MONOCRYL sutures for procedures which require high initial tensile strength diminishing over 2 weeks postoperatively. These include subcuticular closure and soft tissue approximations and ligations, with the exception of neural, cardiovascular, ophthalmic, and microsurgical applications.

MONOCRYL suture is available dyed (violet) and undyed (natural). Dyed MONOCRYL suture retains 60% to 70% of its original strength at 7 days postimplantation, reduced to 30% to 40% at 14 days, with all

original strength lost by 28 days. At 7 days, undyed MONOCRYL suture retains approximately 50% to 60% of its original strength, and approximately 20% to 30% at 14 days postimplantation. All of the original tensile strength of undyed MONOCRYL suture is lost by 21 days postimplantation. Absorption is essentially complete at 91 to 119 days.

#### **COATED VICRYL\* (POLYGLACTIN 910) SUTURE**

This material fills the need for a smoother synthetic absorbable suture that will pass through tissue readily with minimal drag. Coated VICRYL sutures facilitate ease of handling, smooth tie down and unsurpassed knot security.

The coating is a combination of equal parts of copolymer of lactide and glycolide (*polyglactin 370*), plus calcium stearate which is used extensively in pharmaceuticals and food. Calcium stearate is a salt of calcium and stearic acid, both of which are present in the body and constantly metabolized and excreted. The result of this mixture is an outstandingly absorbable, adherent, nonflaking lubricant.

At 2 weeks postimplantation, approximately 75% of the tensile strength of coated VICRYL suture remains. Approximately 50% of tensile strength is retained at 3 weeks for sizes 6-0 and larger. At 3 weeks, 40% of tensile strength is retained for sizes 7-0 and smaller. At 4 weeks, 25% of the original strength is retained for sizes 6-0 and larger. All of the original tensile strength is lost by five weeks post implantation. Absorption of coated

VICRYL suture is essentially complete between 56 and 70 days.

Lactide and glycolide acids are readily eliminated from the body, primarily in urine. As with uncoated sutures, coated VICRYL sutures elicit only a mild tissue reaction during absorption. Their safety and effectiveness in neural and cardiovascular tissue have not been established. Transcutaneous or conjunctival sutures remaining in place longer than 7 days may cause localized irritation and should be removed as indicated. Coated VICRYL sutures are available as braided dyed violet or undyed natural strands in a variety of lengths with or without needles.

#### **COATED VICRYL PLUS ANTIBACTERIAL (POLYGLACTIN 910) SUTURE**

This synthetic, absorbable, sterile, surgical suture is a copolymer made from 90% glycolide and 10% L-lactide. Coated VICRYL *Plus* Antibacterial Suture is coated with a mixture composed of equal parts of copolymer of glycolide and lactide (*polyglactin 370*) and calcium stearate. Coated VICRYL *Plus* Antibacterial suture contains IRGACARE MP\*, one of the purest forms of the broad-spectrum antibacterial agent triclosan.

Coated VICRYL *Plus* Antibacterial suture offers protection against bacterial colonization of the suture.

*In vivo* studies demonstrate that Coated VICRYL *Plus* Antibacterial suture has a zone of inhibition that is effective against the pathogens that most often cause surgical site infection (SSI) – *Staphylococcus aureus*, methicillin-resistant *Staphylococcus aureus* (MRSA), *Staphylococcus epidermidis*, methicillin-resistant

*Staphylococcus epidermidis* (MRSE).<sup>3</sup> *In vivo* studies demonstrate that VICRYL *Plus* Antibacterial suture has no adverse effect on normal wound healing.<sup>2</sup>

Coated VICRYL *Plus* Antibacterial suture performs and handles the same as Coated VICRYL suture. Coated VICRYL *Plus* Antibacterial suture has the same dependable construction as Coated VICRYL suture. *In vivo* testing by surgeons demonstrates the same excellence in performance and handling.

The suture is available undyed (natural) or dyed. Coated VICRYL *Plus* suture is indicated for use in general soft tissue approximation and/or ligation requiring medium support, except for ophthalmic, cardiovascular and neurological tissues. Frequent uses include general closure, bowel, orthopedic, and plastic surgery.

Coated VICRYL *Plus* Antibacterial suture retains approximately 75% of the original tensile strength at two weeks post implantation. At three weeks, approximately 50% of the original strength is retained. At four weeks, approximately 25% of the original strength is retained. All of the original tensile strength is lost by five weeks post implantation. Absorption of Coated VICRYL *Plus* Antibacterial Suture is essentially complete between 56 and 70 days.

#### **PDS\* II (POLYDIOXANONE) SUTURE**

Comprised of the polyester poly (p-dioxanone), this monofilament represents a significant advance in suturing options. It combines the features of soft, pliable, monofilament construction with absorbability and extended wound

\* Trademark



support for up to 6 weeks. It elicits only a slight tissue reaction. This material is well-suited for many types of soft tissue approximation, including pediatric cardiovascular, orthopaedic, gynecologic, ophthalmic, plastic, digestive, and colonic surgeries.

Like other synthetic absorbable sutures, PDS II sutures are absorbed *in vivo* through hydrolysis. Approximately 70% of tensile strength remains 2 weeks postimplantation, 50% at 4 weeks, and 25% at 6 weeks. Absorption is minimal until about the 90th day postoperatively and essentially complete within 6 months. The safety and effectiveness of PDS II sutures in microsurgery, neural tissue, and adult cardiovascular tissue have not been established. PDS II sutures are available clear or dyed violet to enhance visibility.

## NONABSORBABLE SUTURES

The U.S.P. classifies nonabsorbable surgical sutures as follows:

- **CLASS I**—Silk or synthetic fibers of monofilament, twisted, or braided construction.
- **CLASS II**—Cotton or linen fibers, or coated natural or synthetic fibers where the coating contributes to suture thickness without adding strength.
- **CLASS III**—Metal wire of monofilament or multifilament construction.

## SURGICAL SILK

For many surgeons, *surgical silk* represents the standard handling performance by which newer synthetic materials are judged,

especially due to its superior handling characteristics. Silk filaments can be twisted or braided, the latter providing the best handling qualities.

Raw silk is a continuous filament spun by the silkworm moth larva to make its cocoon. Cream or orange-colored in its raw state, each silk filament is processed to remove natural waxes and sericin gum, which is exuded by the silkworm as it spins its cocoon. The gum holds the cocoon together, but is of no benefit to the quality of braided surgical silk sutures.

ETHICON degums the silk for most suture sizes before the braiding process. This allows for a tighter, more compact braid which significantly improves suture quality. After braiding, the strands are dyed, scoured and stretched, and then impregnated and coated with a mixture of waxes or silicone. Each of these steps is critical to the quality of the finished suture and must be carried out in precise order. Surgical silk is usually dyed black for easy visibility in tissue.

Raw silk is graded according to strength, uniformity of filament diameter, and freedom from defects. Only top grades of silk filaments are used to produce PERMA-HAND\* surgical silk sutures.

Surgical silk loses tensile strength when exposed to moisture and should be used dry. Although silk is classified by the U.S.P. as a nonabsorbable suture, long-term *in vivo* studies have shown that it loses most or all of its tensile strength in about 1 year and usually

cannot be detected in tissue after 2 years. Thus, it behaves in reality as a very slowly absorbing suture.

## SURGICAL STAINLESS STEEL

The essential qualities of surgical stainless steel sutures include the absence of toxic elements, flexibility, and fine wire size. Both monofilament and twisted multifilament varieties are high in tensile strength, low in tissue reactivity, and hold a knot well. Provided that the sutures do not fragment, there is little loss of tensile strength in tissues. The 316L (low carbon) stainless steel alloy formula used in the manufacture of these sutures offers optimum metal strength, flexibility, uniformity, and compatibility with stainless steel implants and prostheses. Stainless steel sutures may also be used in abdominal wall closure, sternum closure, retention, skin closure, a variety of orthopaedic procedures, and neurosurgery.

Disadvantages associated with alloy sutures include difficulty in handling; possible cutting, pulling, and tearing of the patient's tissue; fragmentation; barbing; and kinking, which renders the stainless steel suture useless. When used for bone approximation and fixation, asymmetrical twisting of the wire will lead to potential buckling, wire fracture, or subsequent wire fatigue. Incomplete wire fixation under these circumstances will permit movement of the wire, resulting in postoperative pain and possible dehiscence.

Surgical stainless steel sutures should not be used when a prosthesis of another alloy is

DIAMETER	U.S.P.	B & S
.0031 inch	6-0	40
.0040	6-0	38
.0056	5-0	35
.0063	4-0	34
.0080	4-0	32
.0100	3-0	30
.0126	2-0	28
.0159	0	26
.0179	1	25
.0201	2	24
.0226	3	23
.0253	4	22
.0320	5	20
.0360	6	19
.0400	7	18

**TABLE 4**

**SURGICAL STAINLESS STEEL: WIRE GAUGE EQUIVALENTS**

implanted since an unfavorable electrolytic reaction may occur.

Above all, stainless steel sutures pose a safety risk. They easily tear surgical gloves when handled and may puncture the surgeon's own skin—putting both physician and patient at risk of transmitted immunodeficiency virus or hepatitis. Many surgeons refer to wire size by the Brown & Sharpe (B & S) gauge of 40 (smallest diameter) to 18 (largest diameter). ETHICON labels surgical stainless steel with both the B & S and U.S.P. diameter size classifications.

ETHICON packaging of surgical stainless steel maintains the integrity of the product by eliminating kinking and bending of strands. Just as important, it presents the strands in a safe manner for all members of the surgical team who handle them.

**SYNTHETIC NONABSORBABLE SUTURES**

Nylon sutures are a polyamide polymer derived by chemical synthesis. Because of their elasticity, they are particularly well-suited for retention and skin closure. They may be clear, or dyed green or black for better visibility.

**ETHILON\* NYLON SUTURE**

These sutures are extruded into noncapillary single or monofilament strands characterized by high tensile strength and extremely low tissue reactivity. They degrade *in vivo* at a rate of approximately 15% to 20% per year by hydrolysis. ETHILON sutures in sizes 10-0 and 6-0 and larger are produced from a special grade of nylon 6. The medical grade polyamide nylon 6-6 is used for sizes 7-0 and finer. While both grades permit good handling, monofilament nylon sutures have a tendency to return to their original straight extruded state (a property

known as "memory"). Therefore, more throws in the knot are required to securely hold monofilament than braided nylon sutures.

Monofilament nylon in a wet or damp state is more pliable and easier to handle than dry nylon. A limited line of ETHILON sutures (sizes 3-0 through 6-0) are pre-moistened or "pliable" for use in cosmetic plastic surgery. This process enhances the handling and knot tying characteristics to approximate that of braided sutures.

ETHILON sutures are frequently used in ophthalmology and micro-surgery procedures in very fine sizes. For this reason, sizes 9-0 and 10-0 have an intensified black dye for high visibility.

**NUROLON\* NYLON SUTURE**

This suture is composed of filaments of nylon that have been tightly braided into a multifilament strand. Available in white or dyed black, NUROLON sutures look, feel, and handle like silk. However, NUROLON sutures have more strength and elicit less tissue reaction than silk. Braided nylon may be used in all tissues where multifilament nonabsorbable sutures are acceptable. Braided nylon sutures generally lose 15% to 20% of their tensile strength per year in tissue by hydrolyzation.

*Polyester fiber suture* is comprised of untreated fibers of polyester (polyethylene terephthalate) closely braided into a multifilament strand. They are stronger than natural fibers, do not weaken when wetted prior to use, and cause minimal tissue reaction. Available white or

\* Trademark

dyed green, polyester fiber sutures are among the most acceptable for vascular synthetic prostheses.

#### **MERSILENE\* POLYESTER FIBER SUTURE**

The first synthetic braided suture material shown to last indefinitely in the body, MERSILENE sutures provide precise, consistent suture tension. They minimize breakage and virtually eliminate the need to remove irritating suture fragments postoperatively. Because it is uncoated, MERSILENE suture has a higher coefficient of friction when passed through tissue.

#### **ETHIBOND\* EXCEL POLYESTER SUTURE**

ETHIBOND *EXCEL* sutures are uniformly coated with polybutylate, a biologically inert, nonabsorbable compound which adheres itself to the braided polyester fiber strand. Polybutylate was the first synthetic coating developed specifically as a surgical suture lubricant. The coating eases the passage of the braided strands through tissue and provides excellent pliability, handling qualities, and smooth tie-down with each throw of the knot. Both the suture material and the coating are pharmacologically inactive. The sutures elicit minimal tissue reaction and retain their strength *in vivo* for extended periods. ETHIBOND\* *EXCEL* sutures are used primarily in cardiovascular surgery, for vessel anastomosis, and placement of prosthetic materials.

ETHIBOND *EXCEL* sutures are also available attached to TFE polymer felt pledgets. Pledgets serve to prevent possible tearing of adjacent friable tissue.

Pledgets are used routinely in valve replacement procedures (to prevent the annulus from tearing when the prosthetic valve is seated and the sutures are tied), and in situations where extreme deformity, distortion, or tissue destruction at the annulus has occurred.

*Polypropylene* is an isostatic crystalline stereoisomer of a linear hydrocarbon polymer permitting little or no saturation. Manufactured by a patented process which enhances pliability and handling, polypropylene monofilament sutures are not subject to degradation or weakening by tissue enzymes. They cause minimal tissue reaction and hold knots better than most other synthetic monofilament materials.

#### **PROLENE\* POLYPROPYLENE SUTURE**

Widely used in general, cardiovascular, plastic, and orthopaedic surgery, PROLENE sutures do not adhere to tissue and are therefore efficacious as a pull-out suture. PROLENE sutures are relatively biologically inert, offering proven strength, reliability and versatility. PROLENE sutures are recommended for use where minimal suture reaction is desired, such as in contaminated and infected wounds to minimize later sinus formation and suture extrusion. They are available clear or dyed blue.

#### **PRONOVA\* POLY (HEXAFLUOROPROPYLENE-VDF) SUTURE**

This monofilament nonabsorbable suture is a polymer blend of poly (vinylidene fluoride) and poly

(vinylidene fluoride-cohexafluoropropylene). This suture resists involvement in infection and has been successfully employed in contaminated and infected wounds to eliminate or minimize later sinus formation and suture extrusion. Furthermore, the lack of adherence to tissues has facilitated the use of PRONOVA suture as a pull-out suture.

This material is well-suited for many types of soft tissue approximation and ligation, including use in cardiovascular, ophthalmic and neurological procedures.

Table 5 gives an overview of the many suturing options that have been discussed in this section. (See attached chart )

## **COMMON SUTURING TECHNIQUES**

### **LIGATURES**

A suture tied around a vessel to occlude the lumen is called a *ligature* or *tie*. It may be used to effect hemostasis or to close off a structure to prevent leakage. There are two primary types of ligatures.

*Free tie* or *freehand ligatures* are single strands of suture material used to ligate a vessel, duct, or other structure. After a hemostat or other similar type of surgical clamp has been placed on the end of the structure, the suture strand is tied around the vessel under the tip of the hemostat. The hemostat is removed after the first throw and the surgeon tightens the knot using his or her fingertips, taking care to avoid instrument damage to the



Free tie

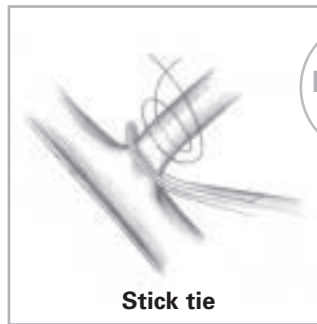

Stick tie

FIGURE 1

## LIGATURES

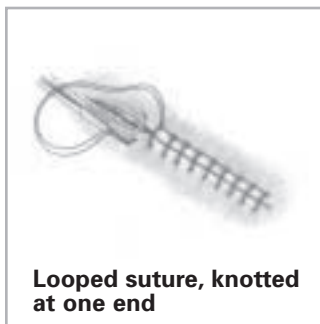

Looped suture, knotted at one end

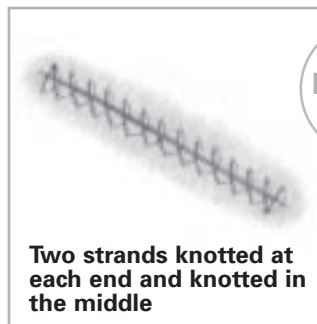

Two strands knotted at each end and knotted in the middle

FIGURE 2

## CONTINUOUS SUTURING TECHNIQUES

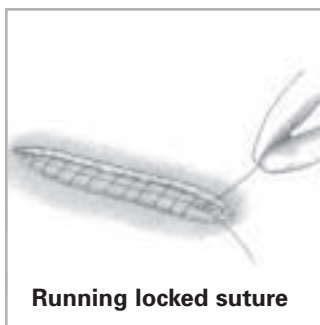

Running locked suture

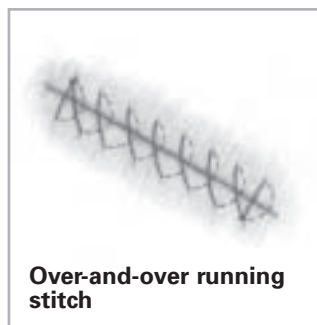

Over-and-over running stitch

suture. Additional throws are added as needed to square and secure the knot. *Stick tie*, *suture ligature*, or *transfixion suture* is a strand of suture material attached to a needle to ligate a vessel, duct, or other structure. This technique is used on deep structures where placement of a hemostat is difficult or on vessels of large diameter. The needle is passed through the structure or adjacent tissue first to anchor the suture, then tied around the structure. Additional throws are used as needed to secure the knot.

## THE PRIMARY SUTURE LINE

The *primary suture line* is the line of sutures that holds the wound edges in approximation during healing by first intention. It may consist of a continuous strand of material or a series of interrupted suture strands. Other types of primary sutures, such as deep sutures, buried sutures, purse-string sutures, and subcuticular sutures, are used for specific indications. Regardless of technique, a surgical needle is attached to the suture strand to permit repeated passes through tissue.

## CONTINUOUS SUTURES

Also referred to as *running stitches*, continuous sutures are a series of stitches taken with one strand of material. The strand may be tied to itself at each end, or looped, with both cut ends of the strand tied together. A continuous suture line can be placed rapidly. It derives its strength from tension distributed evenly along the full length of the suture strand. However, care must be taken to apply firm tension, rather than tight tension, to avoid

## INTERRUPTED SUTURING TECHNIQUES

FIGURE 3

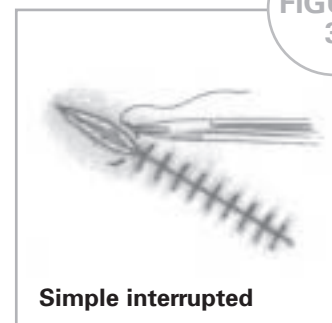

Simple interrupted

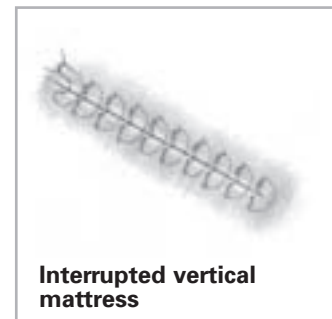

Interrupted vertical mattress



Interrupted horizontal mattress



## ABSORBABLE SUTURES

SUTURE	TYPES	COLOR OF MATERIAL	RAW MATERIAL	TENSILE STRENGTH RETENTION <i>in vivo</i>	ABSORPTION RATE	TISSUE REACTION
Surgical Gut Suture	Plain	Yellowish-tan Blue Dyed	Collagen derived from healthy beef and sheep.	Individual patient characteristics can affect rate of tensile strength loss.	Absorbed by proteolytic enzymatic digestive process.	Moderate reaction
Surgical Gut Suture	Chromic	Brown Blue Dyed	Collagen derived from healthy beef and sheep.	Individual patient characteristics can affect rate of tensile strength loss.	Absorbed by proteolytic enzymatic digestive process.	Moderate reaction
Coated VICRYL* <i>RAPIDE</i> (polyglactin 910) Suture	Braided	Undyed (Natural)	Copolymer of lactide and glycolide coated with 370 and calcium stearate.	Approximately 50% remains at 5 days. All tensile strength is lost at approximately 14 days.	Essentially complete between 42 days. Absorbed by hydrolysis.	Minimal to moderate acute inflammatory reaction
MONOCRYL* (poliglecaprone 25) Suture	Monofilament	Undyed (Natural) Violet	Copolymer of glycolide and epsilon-caprolactone.	Approximately 50-60% (violet: 60-70%) remains at 1 week. Approximately 20-30% (violet: 30-40%) remains at 2 weeks. Lost within 3 weeks (violet: 4 weeks).	Complete at 91-119 days. Absorbed by hydrolysis.	Minimal acute inflammatory reaction
Coated VICRYL* <i>Plus</i> Antibacterial (polyglactin 910) Suture	Braided Monofilament	Undyed (Natural) Violet	Copolymer of lactide and glycolide coated with 370 and calcium stearate.	Approximately 75% remains at two weeks. Approximately 50% remains at three weeks, 25% at four weeks.	Essentially complete between 56-70 days. Absorbed by hydrolysis.	Minimal acute inflammatory reaction
Coated VICRYL* (polyglactin 910) Suture	Braided Monofilament	Violet Undyed (Natural)	Copolymer of lactide and glycolide coated with 370 and calcium stearate.	Approximately 75% remains at two weeks. Approximately 50% remains at three weeks, 25% at four weeks.	Essentially complete between 56-70 days. Absorbed by hydrolysis.	Minimal acute inflammatory reaction
PDS* II (polydioxanone) Suture	Monofilament	Violet Blue Clear	Polyester polymer.	Approximately 70% remains at 2 weeks. Approximately 50% remains at 4 weeks. Approximately 25% remains at 6 weeks.	Minimal until about 90th day. Essentially complete within 6 months. Absorbed by slow hydrolysis.	Slight reaction

## NONABSORBABLE SUTURES

PERMA-HAND* Silk Suture	Braided	Violet White	Organic protein called fibrin.	Progressive degradation of fiber may result in gradual loss of tensile strength over time.	Gradual encapsulation by fibrous connective tissue.	Acute inflammatory reaction
Surgical Stainless Steel Suture	Monofilament Multifilament	Silver metallic	316L stainless steel.	Indefinite.	Nonabsorbable.	Minimal acute inflammatory reaction
ETHILON* Nylon Suture	Monofilament	Violet Green Undyed (Clear)	Long-chain aliphatic polymers Nylon 6 or Nylon 6,6.	Progressive hydrolysis may result in gradual loss of tensile strength over time.	Gradual encapsulation by fibrous connective tissue.	Minimal acute inflammatory reaction
NUROLON* Nylon Suture	Braided	Violet Green Undyed (Clear)	Long-chain aliphatic polymers Nylon 6 or Nylon 6,6.	Progressive hydrolysis may result in gradual loss of tensile strength over time.	Gradual encapsulation by fibrous connective tissue.	Minimal acute inflammatory reaction
MERSILENE* Polyester Fiber Suture	Braided Monofilament	Green Undyed (White)	Poly (ethylene terephthalate).	No significant change known to occur <i>in vivo</i> .	Gradual encapsulation by fibrous connective tissue.	Minimal acute inflammatory reaction
ETHIBOND* <i>EXCEL</i> Polyester Fiber Suture	Braided	Green Undyed (White)	Poly (ethylene terephthalate) coated with polybutylate.	No significant change known to occur <i>in vivo</i> .	Gradual encapsulation by fibrous connective tissue.	Minimal acute inflammatory reaction
PROLENE* Polypropylene Suture	Monofilament	Clear Blue	Isotactic crystalline stereoisomer of polypropylene.	No subject to degradation or weakening by action of tissue enzymes.	Nonabsorbable.	Minimal acute inflammatory reaction
PRONOVA* POLY (hexafluoropropylene-VDF) Suture	Monofilament	Blue	Polymer blend of poly (vinylidene fluoride) and poly (vinylidene fluoride-cohexafluoropropylene).	No subject to degradation or weakening by action of tissue enzymes.	Nonabsorbable.	Minimal acute inflammatory reaction

**TABLE 5**

**SUTURING OPTIONS: MATERIALS, CHARACTERISTICS, AND APPLICATIONS**

CONTRAINDICATIONS	FREQUENT USES	HOW SUPPLIED	COLOR CODE OF PACKETS
Being absorbable, should not be used where extended approximation of tissues under stress is required. Should not be used in patients with known sensitivities or allergies to collagen or chromium.	General soft tissue approximation and/or ligation, including use in ophthalmic procedures. Not for use in cardiovascular and neurological tissues.	7-0 thru 3 with and without needles, and on LIGAPAK dispensing reels 0 thru 1 with CONTROL RELEASE needles	Yellow
Being absorbable, should not be used where extended approximation of tissues under stress is required. Should not be used in patients with known sensitivities or allergies to collagen or chromium.	General soft tissue approximation and/or ligation, including use in ophthalmic procedures. Not for use in cardiovascular and neurological tissues.	7-0 thru 3 with and without needles, and on LIGAPAK dispensing reels 0 thru 1 with CONTROL RELEASE needles	Beige
Should not be used where extended approximation of tissue under stress is required or where wound support beyond 7 days is required.	Superficial soft tissue approximation of skin and mucosa only. Not for use in ligation, ophthalmic, cardiovascular or neurological procedures.	5-0 thru 1 with needles	Red
Being absorbable, should not be used where extended approximation of tissue under stress is required. Undyed not indicated for use in fascia.	General soft tissue approximation and/or ligation. Not for use in cardiovascular and neurological tissues, microsurgery, or ophthalmic surgery.	6-0 thru 2 with and without needles 3-0 thru 1 with CONTROL RELEASE needles	Coral
Being absorbable, should not be used where extended approximation of tissue is required.	General soft tissue approximation and/or ligation. Not for use in cardiovascular and neurological tissues.	5-0 thru 2 with and without needles	Violet
Being absorbable, should not be used where extended approximation of tissue is required.	General soft tissue approximation and/or ligation, including use in ophthalmic procedures. Not for use in cardiovascular and neurological tissues.	8-0 thru 3 with and without needles, and on LIGAPAK dispensing reels 4-0 thru 2 with CONTROL RELEASE needles; 8-0 with attached beads for ophthalmic use	Violet
Being absorbable, should not be used where prolonged approximation of tissues under stress is required. Should not be used with prosthetic devices, such as heart valves or synthetic grafts.	All types of soft tissue approximation, including pediatric cardiovascular and ophthalmic procedures. Not for use in adult cardiovascular tissue, microsurgery, and neural tissue.	9-0 thru 2 with needles 4-0 thru 2 with CONTROL RELEASE needles 9-0 thru 7-0 with needles 7-0 thru 1 with needles	Silver

Should not be used in patients with known sensitivities or allergies to silk.	General soft tissue approximation and/or ligation, including cardiovascular, ophthalmic and neurological procedures.	9-0 thru 5 with and without needles, and on LIGAPAK dispensing reels 4-0 thru 1 with CONTROL RELEASE needles	Light Blue
Should not be used in patients with known sensitivities or allergies to 316L stainless steel, or constituent metals such as chromium and nickel.	Abdominal wound closure, hernia repair, sternal closure and orthoedic procedures including cerclage and tendon repair.	10-0 thru 7 with and without needles	Yellow-Ochre
Should not be used where permanent retention of tensile strength is required.	General soft tissue approximation and/or ligation, including cardiovascular, ophthalmic and neurological procedures.	11-0 thru 2 with and without needles	Mint Green
Should not be used where permanent retention of tensile strength is required.	General soft tissue approximation and/or ligation, including cardiovascular, ophthalmic and neurological procedures.	6-0 thru 1 with and without needles 4-0 thru 1 with CONTROL RELEASE needles	Mint Green
None known.	General soft tissue approximation and/or ligation, including cardiovascular, ophthalmic and neurological procedures.	6-0 thru 5 with and without needles 10-0 and 11-0 for ophthalmic (green monofilament); 0 with CONTROL RELEASE needles	Turquoise
None known.	General soft tissue approximation and/or ligation, including cardiovascular, ophthalmic and neurological procedures.	7-0 thru 5 with and without needles 4-0 thru 1 with CONTROL RELEASE needles; various sizes attached to TFE polymer pledgets	Orange
None known.	General soft tissue approximation and/or ligation, including cardiovascular, ophthalmic and neurological procedures.	6-0 thru 2 (clear) with and without needles; 10-0 thru 8-0 and 6-0 thru 2 with and without needles; 0 thru 2 with CONTROL RELEASE needles; various sizes attached to TFE polymer pledgets	Deep Blue
None known.	General soft tissue approximation and/or ligation, including cardiovascular, ophthalmic and neurological procedures.	6-0 through 5-0 with TAPERCUT* surgical needle 8-0 through 5-0 with taper point needle	Royal Blue

\* Trademark



tissue strangulation. Excessive tension and instrument damage should be avoided to prevent suture breakage which could disrupt the entire line of a continuous suture.

Continuous suturing leaves less foreign body mass in the wound. In the presence of infection, it may be desirable to use a monofilament suture material because it has no interstices which can harbor microorganisms. This is especially critical as a continuous suture line can transmit infection along the entire length of the strand. A continuous one layer mass closure may be used on peritoneum and/or fascial layers of the abdominal wall to provide a temporary seal during the healing process.

### INTERRUPTED SUTURES

*Interrupted sutures* use a number of strands to close the wound. Each strand is tied and cut after insertion. This provides a more secure closure, because if one suture breaks, the remaining sutures will hold the wound edges in approximation.

Interrupted sutures may be used if a wound is infected, because microorganisms may be less likely to travel along a series of interrupted stitches.

### DEEP SUTURES

*Deep sutures* are placed completely under the epidermal skin layer. They may be placed as continuous or interrupted sutures and are not removed postoperatively.

### BURIED SUTURES

*Buried sutures* are placed so that the knot protrudes to the inside, under the layer to be closed. This tech-

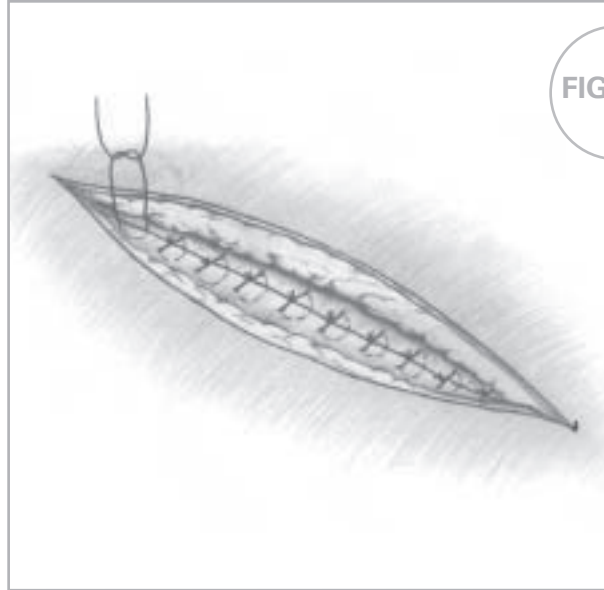

FIGURE 4

**DEEP SUTURES**

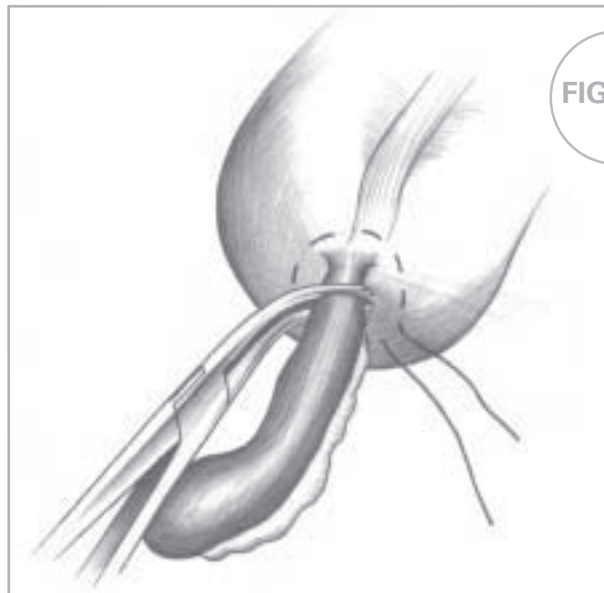

FIGURE 5

**PURSE-STRING SUTURES**

nique is useful when using large diameter permanent sutures on deeper layers in thin patients who may be able to feel large knots that are not buried.

### PURSE-STRING SUTURES

*Purse-string sutures* are continuous sutures placed around a lumen and tightened like a drawstring to invert the opening. They may be placed around the stump of the appendix, in the bowel to secure an intestinal stapling device, or in an

organ prior to insertion of a tube (such as the aorta, to hold the cannulation tube in place during an open heart procedure).

### SUBCUTICULAR SUTURES

*Subcuticular sutures* are continuous or interrupted sutures placed in the dermis, beneath the epithelial layer. Continuous subcuticular sutures are placed in a line parallel to the wound. This technique involves taking short, lateral stitches the full length of the wound. After the

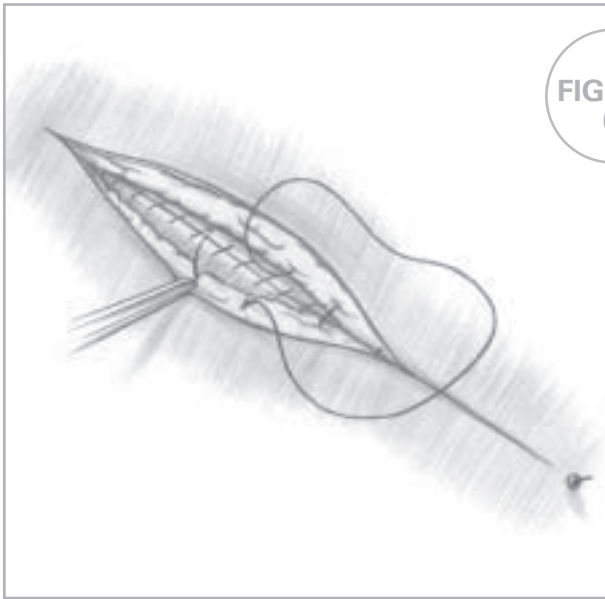
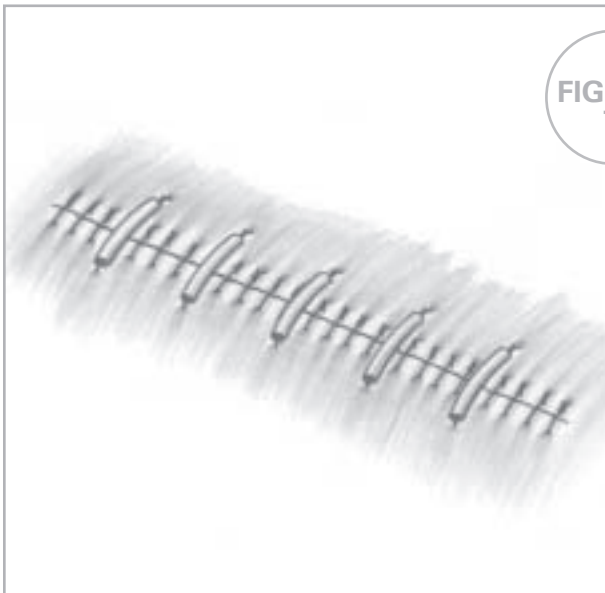
FIGURE  
6**SUBCUTANEOUS  
SUTURES**FIGURE  
7**RETENTION  
SUTURE  
BOLSTER**

suture has been drawn taut, the distal end is anchored in the same manner as the proximal end. This may involve tying or any of a variety of anchoring devices. Subcuticular suturing may be performed with absorbable suture which does not require removal, or with monofilament nonabsorbable suture that is later removed by simply removing the anchoring device at one end and pulling the opposite end.

**THE SECONDARY  
SUTURE LINE**

A secondary line of sutures may be used:

- To reinforce and support the primary suture line, eliminate dead space, and prevent fluid accumulation in an abdominal wound during healing by first intention. When used for this purpose, they may also be called retention, stay, or tension sutures.

- To support wounds for healing by second intention.
- For secondary closure following wound disruption when healing by third intention.

**NOTE:** If secondary sutures are used in cases of nonhealing, they should be placed in opposite fashion from the primary sutures (i.e., interrupted if the primary sutures were continuous, continuous if the primary sutures were interrupted).

*Retention sutures* are placed approximately 2 inches from each edge of the wound. The tension exerted lateral to the primary suture line contributes to the tensile strength of the wound. *Through-and-through sutures* are placed from inside the peritoneal cavity through all layers of the abdominal wall, including the peritoneum. They should be inserted before the peritoneum is closed using a simple interrupted stitch. The wound may be closed in layers for a distance of approximately three-fourths its length. Then the retention sutures in this area may be drawn together and tied. It is important that a finger be placed within the abdominal cavity to prevent strangulation of the viscera in the closure. The remainder of the wound may then be closed. Prior to tightening and tying the final retention sutures, it is important to explore the abdomen again with a finger to prevent strangulation of viscera in the closure. The remainder of the wound may then be closed.

Retention sutures utilize nonabsorbable suture material. They should therefore be removed as soon as the danger of sudden

increases in intra-abdominal pressure is over— usually 2 to 6 weeks, with an average of 3 weeks.

### STITCH PLACEMENT

Many types of stitches are used for both continuous and interrupted suturing. In every case, equal "bites" of tissue should be taken on each side of the wound. The needle should be inserted from 1 to 3 centimeters from the edge of the wound, depending upon the type and condition of the tissue being sutured.

### KNOT TYING

Of the more than 1,400 different types of knots described in *THE ENCYCLOPEDIA OF KNOTS*, only a few are used in modern surgery. It is of paramount importance that each knot placed for approximation of tissues or ligation of vessels be tied with precision and each must hold with proper tension.

### KNOT SECURITY

The construction of ETHICON\* sutures has been carefully designed to produce the optimum combination of strength, uniformity, and hand for each material. The term *hand* is the most subtle of all suture quality aspects. It relates to the feel of the suture in the surgeon's hands, the smoothness with which it passes through tissue and ties down, the way in which knots can be set and snugged down, and most of all, to the firmness or body of the suture. *Extensibility* relates to the way in which the suture will stretch slightly during knot tying and then recover.

The stretching characteristics provide the signal that alerts the surgeon to the precise moment when the suture knot is snug.

The type of knot tied will depend upon the material used, the depth and location of the incision, and the amount of stress that will be placed upon the wound postoperatively. Multifilament sutures are generally easier to handle and tie than monofilament sutures, however, all the synthetic materials require a specific knotting technique. With multifilament sutures, the nature of the material and the braided or twisted construction provide a high coefficient of friction and the knots remain as they are laid down. In monofilament sutures, on the other hand, the coefficient of friction is relatively low, resulting in a greater tendency for the knot to loosen after it has been tied. In addition, monofilament synthetic polymeric materials possess the property of memory. *Memory* is the tendency not to lie flat, but to return to a given shape set by the material's extrusion process or the suture's packaging. The RELAY\* suture delivery system delivers sutures with minimal package memory due to its unique package design.

Suture knots must be properly placed to be secure. Speed in knot tying frequently results in less than perfect placement of the strands. In addition to variables inherent in the suture materials, considerable variation can be found between knots tied by different surgeons and even between knots tied by the same individual on different occasions.

The general principles of knot tying which apply to all suture materials are:

1. The completed knot must be firm, and so tied that slipping is virtually impossible. The simplest knot for the material is the most desirable.
2. The knot must be as small as possible to prevent an excessive amount of tissue reaction when absorbable sutures are used, or to minimize foreign body reaction to nonabsorbable sutures. Ends should be cut as short as possible.
3. In tying any knot, friction between strands ("sawing") must be avoided as this can weaken the integrity of the suture.

CONTINUOUS SUTURE	INTERRUPTED SUTURES
<b>To appose skin and other tissue</b>	
Over-and-over Subcuticular	Over-and-over Vertical mattress Horizontal mattress
<b>To invert tissue</b>	
Lembert Cushing Connell	Lembert Halsted Purse-string
<b>To evert tissue</b>	
Horizontal mattress	Horizontal mattress

TABLE  
6

COMMONLY  
USED TYPES  
OF STITCHES

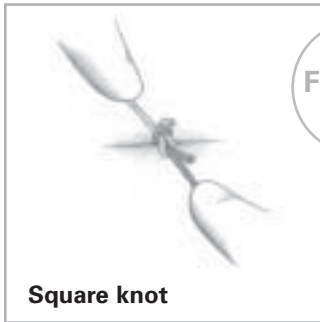
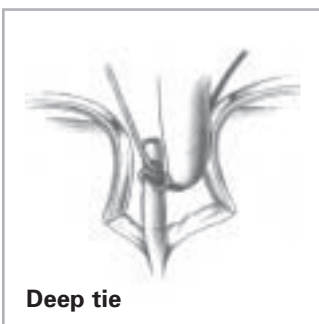
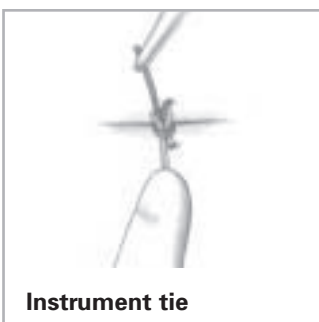

FIGURE 8

**FINISHED SUTURE TIES****Square knot****Surgeon's knot—first throw****Surgeon's knot—second throw****Deep tie****Instrument tie**

4. Care should be taken to avoid damage to the suture material when handling. Avoid the crushing or crimping application of surgical instruments, such as needleholders and forceps, to the strand except when grasping the free end of the suture during an instrument tie.
5. Excessive tension applied by the surgeon will cause breaking of the suture and may cut tissue. Practice in avoiding excessive tension leads to successful use of finer gauge materials.
6. Sutures used for approximation should not be tied too tightly, because this may contribute to tissue strangulation.
7. After the first loop is tied, it is necessary to maintain traction on one end of the strand to avoid loosening of the throw if being tied under any tension.
8. Final tension on final throw should be as nearly horizontal as possible.
9. The surgeon should not hesitate to change stance or position in relation to the patient in order to place a knot securely and flat.
10. Extra ties do not add to the strength of a properly tied and squared knot. They only contribute to its bulk. With some synthetic materials, knot security requires the standard surgical technique to flat and square ties with additional throws if indicated by surgical circumstance and the experience of the surgeon.

**KNOT TYING TECHNIQUES MOST OFTEN USED**

An important part of good suturing technique is correct method in knot tying. A seesaw motion, or the sawing of one strand down over another until the knot is formed, may materially weaken sutures to the point that they may break when the second throw is made, or even worse, in the postoperative period when the suture is further weakened by increased tension or motion. If the two ends of the suture are pulled in opposite directions with uniform rate and tension, the knot may be tied more securely.

Some procedures involve tying knots with the fingers, using one or two hands; others involve tying with the help of instruments. Perhaps the most complex method of knot tying is done during endoscopic procedures, when the surgeon must manipulate instruments from well outside the body cavity.

Following are the most frequently used knot tying techniques with accompanying illustrations of finished knots.

**SQUARE KNOT**

The two-hand square knot is the easiest and most reliable for tying most suture materials. It may be used to tie surgical gut, virgin silk, surgical cotton, and surgical stainless steel. Standard technique of flat and square ties with additional throws if indicated by the surgical circumstance and the experience of the operator should be used to tie MONOCRYL\* (poliglecaprone 25) suture, VICRYL\* suture, Coated VICRYL\* suture, Coated VICRYL\* RAPIDE (polyglactin 910) suture,

\* Trademark



PDS\* II (polydioxanone) suture, ETHILON\* nylon suture, ETHIBOND\* EXCEL polyester suture, PERMA-HAND\* silk suture, PRONOVA\* poly (hexafluoropropylene-VDF) suture, and PROLENE\* polypropylene suture.

Wherever possible, the square knot is tied using the two-hand technique. On some occasions it will be necessary to use one hand, either the left or the right, to tie a square knot.

**CAUTION:** If the strands of a square knot are inadvertently incorrectly crossed, a granny knot will result. Granny knots are not recommended because they have a tendency to slip when subjected to increased stress.

### SURGEON'S OR FRICTION KNOT

The surgeon's or friction knot is recommended for tying VICRYL\* suture, Coated VICRYL\* suture, ETHIBOND\* EXCEL polyester suture, ETHILON\* nylon suture, MERSILENE\* polyester fiber suture, NUROLON\* nylon suture, PRONOVA\* poly (hexafluoropropylene-VDF) suture, and PROLENE\* polypropylene suture. The surgeon's knot also may be performed using a one-hand technique.

### DEEP TIE

Tying deep in a body cavity can be difficult. The square knot must be firmly snugged down as in all situations. However, the operator must avoid upward tension which may tear or avulse the tissue.

### LIGATION USING A HEMOSTATIC CLAMP

Frequently it is necessary to ligate a blood vessel or tissue grasped in a hemostatic clamp to achieve hemostasis in the operative field.

### INSTRUMENT TIE

The instrument tie is useful when one or both ends of the suture material are short. For best results, exercise caution when using a needleholder with any monofilament suture, as repeated bending may cause these sutures to break.

### ENDOSCOPIC KNOT TYING TECHNIQUES

During an endoscopic procedure, a square knot or surgeon's knot may be tied either outside the abdomen and pushed down into the body through a trocar (extracorporeal) or directly within the abdominal cavity (intracorporeal).

In *extracorporeal knot tying*, the suture appropriately penetrates the tissue, and both needle and suture are removed from the body cavity, bringing both suture ends outside of the trocar. Then a series of half-hitches are tied, each one being pushed down into the cavity and tightened with an endoscopic knot pusher.

*Intracorporeal knot tying* is performed totally within the abdominal cavity. After the suture has penetrated the tissue, the needle

is cut from the suture and removed. Several loops are made with the suture around the needleholder, and the end of the suture is pulled through the loops. This technique is then repeated to form a surgeon's knot, which is tightened by the knot pusher.

In both extracorporeal and intracorporeal knot tying, the following principles of suture manipulation on tissue should be observed:

1. Handle tissue as gently as possible to avoid tissue trauma.
2. Grasp as little tissue as possible.
3. Use the smallest suture possible for the task.
4. Exercise care in approximating the knot so that the tissue being approximated is not strangulated.
5. Suture must be handled with care to avoid damage.

### CUTTING THE SECURED SUTURES

Once the knot has been securely tied, the ends must be cut. Before cutting, make sure both tips of the scissors are visible to avoid inadvertently cutting tissue beyond the suture.

Cutting sutures entails running the tip of the scissors lightly down the suture strand to the knot. The ends of surgical gut are left relatively long, approximately 1/4" (6mm) from the knot.

SUTURE LOCATION	TIME FOR SUTURE REMOVAL
Skin on the face and neck	2 to 5 days
Other skin sutures	5 to 8 days
Retention sutures	2 to 6 weeks

TABLE  
7

SUTURE  
REMOVAL



Other materials are cut closer to the knot, approximately  $\frac{1}{8}$ " (3mm), to decrease tissue reaction and minimize the amount of foreign material left in the wound. To ensure that the actual knot is not cut, twist or angle the blades of the scissors prior to cutting. Make certain to remove the cut ends of the suture from the operative site.

## SUTURE REMOVAL

When the external wound has healed so that it no longer needs the support of nonabsorbable suture material, skin sutures must be removed. The length of time the sutures remain in place depends upon the rate of healing and the nature of the wound. General rules are as follows.

Sutures should be removed using aseptic and sterile technique. The surgeon uses a sterile suture removal tray prepared for the procedure. The following steps are taken:

- **STEP 1**—Cleanse the area with an antiseptic. Hydrogen peroxide can be used to remove dried serum encrusted around the sutures.
- **STEP 2**—Pick up one end of the suture with thumb forceps, and cut as close to the skin as possible where the suture enters the skin.
- **STEP 3**—Gently pull the suture strand out through the side opposite the knot with the forceps. To prevent risk of infection, the suture should be removed without pulling any portion that has been outside the skin back through the skin.

**NOTE:** Fast absorbing synthetic or gut suture material tend to lose all tensile strength in 5 to 7 days and can

be removed easily without cutting. A common practice is to cover the skin sutures with PROXI-STRIP\* skin closures during the required healing period. After the wound edges have regained sufficient tensile strength, the sutures may be removed by simply removing the PROXI-STRIP skin closures.

## SUTURE HANDLING TIPS

These guidelines will help the surgical team keep their suture inventory up to date and their sutures in the best possible condition.

1. Read labels.
2. Heed expiration dates and rotate stock.
3. Open only those sutures needed for the procedure at hand.
4. Straighten sutures with a gentle pull. Never crush or rub them.
5. Don't pull on needles.
6. Avoid crushing or crimping suture strands with surgical instruments.

7. Don't store surgical gut near heat.
8. Moisten—but never soak—surgical gut.
9. Do not wet rapidly absorbing sutures.
10. Keep silk dry.
11. Wet linen and cotton to increase their strength.
12. Don't bend stainless steel wire.
13. Draw nylon between gloved fingers to remove the packaging "memory."
14. Arm a needleholder properly.

## SUTURE SELECTION PROCEDURE

### PRINCIPLES OF SUTURE SELECTION

The surgeon has a choice of suture materials from which to select for use in body tissues. Adequate strength of the suture material will prevent suture breakage. Secure knots will prevent knot slippage. But the surgeon must understand the nature of the suture material,



FIGURE 9

**ARMING A NEEDLEHOLDER PROPERLY**

**Grasp the needle one-third to one-half of the distance from the swaged end to the point.**

the biologic forces in the healing wound, and the interaction of the suture and the tissues. The following principles should guide the surgeon in suture selection.

1. When a wound has reached maximal strength, sutures are no longer needed. Therefore:
  - a. Tissues that ordinarily heal slowly such as skin, fascia, and tendons should usually be closed with nonabsorbable sutures. An absorbable suture with extended (up to 6 months) wound support may also be used.
  - b. Tissues that heal rapidly such as stomach, colon and bladder may be closed with absorbable sutures
2. Foreign bodies in potentially contaminated tissues may convert contamination into infection.
3. Where cosmetic results are important, close and prolonged apposition of wounds and avoidance of irritants will produce the best results. Therefore:
  - a. Use the smallest inert monofilament suture materials such as nylon or polypropylene.
  - b. Avoid skin sutures and close subcuticularly whenever possible.
  - c. Under certain circumstances, to secure close apposition of skin edges, a topical skin adhesive or skin closure tape may be used.
4. Foreign bodies in the presence of fluids containing high concentrations of crystalloids may act as a nidus for precipitation and stone formation.

Therefore:

- a. In the urinary and biliary tracts, use rapidly absorbed sutures.
5. Regarding suture size:
- a. Use the finest size suture commensurate with the natural strength of the tissue.
  - b. If the postoperative course of the patient may produce sudden strains on the suture line, reinforce it with retention sutures. Remove them as soon as the patient's condition is stabilized.

### **SURGERY WITHIN THE ABDOMINAL WALL CAVITY**

Entering the abdomen, the surgeon will need to seal or tie off subcutaneous blood vessels immediately after the incision is made, using either an electrosurgical unit designed for this purpose or free ties (ligatures). If ligatures are used, an absorbable suture material is generally preferred. When preparing the ties, the scrub person often prepares one strand on a needle for use as a suture ligature should the surgeon wish to transfix a large blood vessel. Once inside, the type of suture

selected will depend upon the nature of the operation and the surgeon's technique.

### **THE GASTROINTESTINAL TRACT**

Leakage from an anastomosis or suture site is the principal problem encountered performing a procedure involving the gastrointestinal tract. This problem can lead to localized or generalized peritonitis. Sutures should not be tied too tightly in an anastomotic

closure. Wounds of the stomach and intestine are rich in blood supply and may become edematous and hardened. Tight sutures may cut through the tissue and cause leakage. A leak-proof anastomosis can be achieved with either a single or double-layer closure.

For a single-layer closure, interrupted sutures should be placed approximately 1/4" (6mm) apart. Suture is placed through the submucosa, into the muscularis and through the serosa. Because the submucosa provides strength in the gastrointestinal tract, effective closure involves suturing the submucosal layers in apposition without penetrating the mucosa. A continuous suture line provides a tighter seal than interrupted sutures. However, if a continuous suture breaks, the entire line may separate.

Many surgeons prefer to use a double-layer closure, placing a second layer of interrupted sutures through the serosa for insurance. Absorbable VICRYL\* sutures, or chromic gut sutures may be used in either a single or double-layer closure. Surgical silk may also be used for the second layer of a double-layer closure.

Inverted, everted, or end-to-end closure techniques have all been used successfully in this area, but they all have drawbacks. The surgeon must take meticulous care in placing the sutures in the submucosa. Even with the best technique, some leakage may occur. Fortunately, the omentum usually confines the area, and natural body defenses handle the problem.

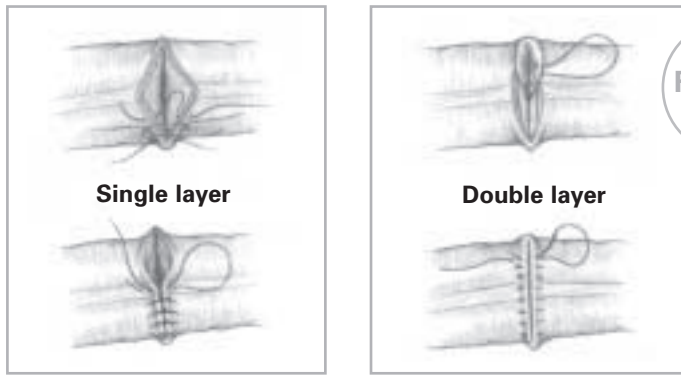

FIGURE 10

### ANASTOMOTIC CLOSURE TECHNIQUE

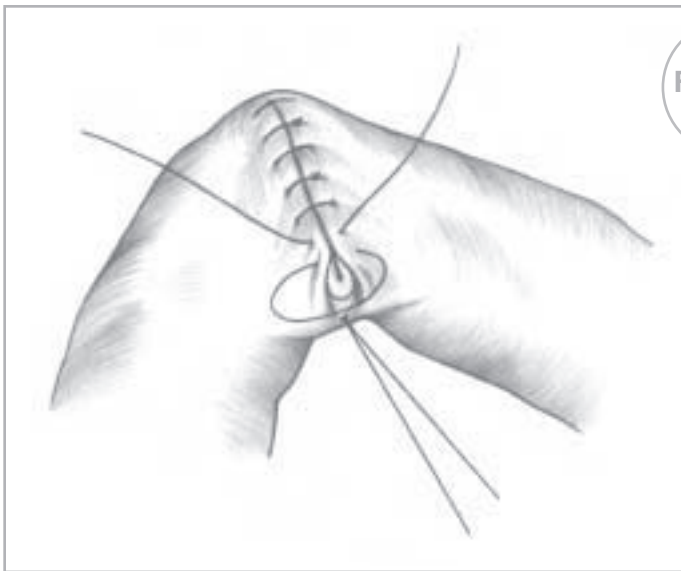

FIGURE 11

### INVERTED CLOSURE TECHNIQUE

#### THE STOMACH

For an organ that contains free hydrochloric acid and potent proteolytic enzymes, the stomach heals surprisingly quickly. Stomach wounds attain maximum strength within 14 to 21 days

postoperatively, and have a peak rate of collagen synthesis at 5 days.

*Absorbable sutures* are usually acceptable in the stomach, although they may produce a moderate reaction in both the wound and normal tissue. Coated VICRYL\* sutures are most commonly used. PROLENE\* sutures may also be used for stomach closure.

#### THE SMALL INTESTINE

Closure of the small intestine presents the same considerations as the stomach. Proximal intestinal contents, primarily bile or pancreatic juices, may cause a severe chemical (rather than bacterial) peritonitis.

If using an inverted closure technique, care must be taken to minimize the cuff of tissue which protrudes into the small sized intestinal lumen in order to avoid partial or complete obstruction. *Absorbable sutures* are usually preferred, particularly because they will not permanently limit the lumen diameter. A *nonabsorbable suture* may be used in the serosal

layer for added assurance. The small intestine heals very rapidly, reaching maximal strength in approximately 14 days.

#### THE COLON

The high microbial content of the colon once made contamination a major concern. But absorbable sutures, once absorbed, leave no channel for microbial migration. Still, leakage of large bowel contents is of great concern as it is potentially more serious than leakage in other areas of the gastrointestinal tract.

The colon is a strong organ—approximately twice as strong in the sigmoid region as in the cecum. Yet, wounds of the colon gain strength at the same rate regardless of their location. This permits the same suture size to be used at either end of the colon. The colon heals at a rate similar to that of the stomach and small intestine. A high rate of collagen synthesis is maintained for a prolonged period (over 120 days). The entire gastrointestinal tract exhibits a loss of collagen and increased collagenous activity immediately following colon anastomosis. Both *absorbable* and *nonabsorbable sutures* may be used for closure of the colon. Placement of sutures in the submucosa, avoiding penetration of the mucosa, will help prevent complications.

#### THE RECTUM

The rectum heals very slowly. Because the lower portion is below the pelvic peritoneum, it has no serosa. A large bite of muscle should be included in an anastomosis, and the sutures should be tied carefully to avoid cutting through the tissues.

\* Trademark

Monofilament sutures reduce the risk of bacterial proliferation in the rectum.

### THE BILIARY TRACT THE GALLBLADDER

Within the gallbladder, the cystic and common bile ducts heal rapidly. Their contents present special considerations for suture selection. The presence of a foreign body such as a suture in an organ that is prone to crystal formation may precipitate the formation of "stones."

Multifilament sutures should probably not be used because it is not always possible to prevent exposure of a suture in the ducts. The surgeon should choose an *absorbable suture* in the finest size possible that leaves the least surface area exposed.

### PARENCHYMATOUS ORGANS THE SPLEEN, LIVER AND KIDNEY

On occasion, a surgeon may be called upon to repair a laceration of one of these vital organs. If large vessels, particularly arteries, within these organs have been severed, they must be located and ligated before attempting to close the defect. Otherwise, hematomas or secondary hemorrhage may occur.

Because these organs are composed chiefly of cells with little connective tissue for support, attempts must be made to coapt the outer fibrous capsule of the torn tissue. In the absence of hemorrhage, little tension is placed on the suture line and only small size sutures need to be used. If the tissue cannot be approximated, tacking a piece of omentum over the defect will usually suffice to

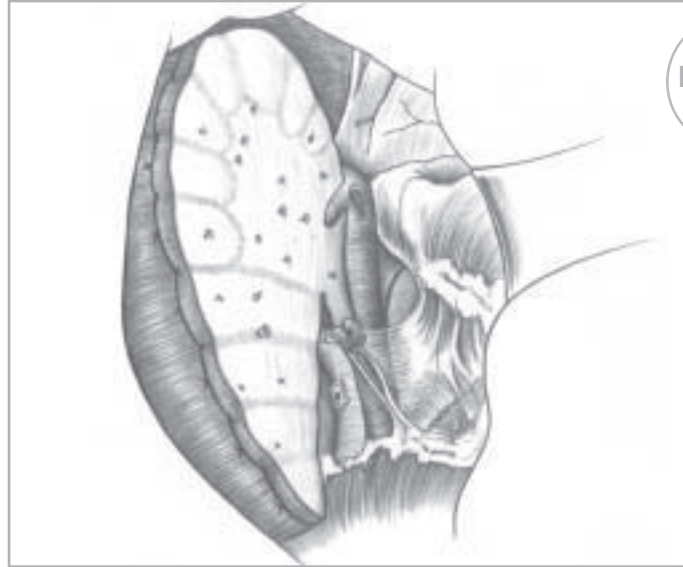

FIGURE  
12

LIVER  
RESECTION

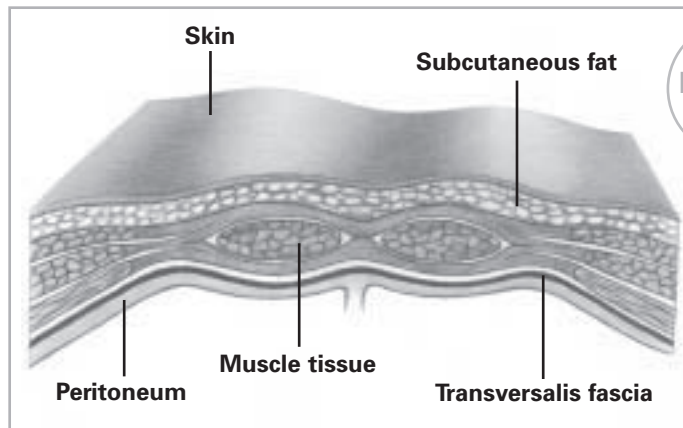

FIGURE  
13

THE  
ABDOMINAL  
WALL

provide closure. Sutures do not need to be placed close together or deeply into the organ.

Lacerations in this area tend to heal rapidly. New fibrous tissue will usually form over the wound with 7 to 10 days.

In a liver resection, suturing of the wedges in a horizontal through-and-through fashion should hold the tissue securely. Large vessels should be tied using VICRYL\* sutures or silk. Raw surfaces can be closed or repaired using VICRYL (polyglactin 910) mesh.

### CLOSING THE ABDOMEN

When closing the abdomen, the closure technique may be more important than the type of suture material used.

#### THE PERITONEUM

The peritoneum, the thin membranous lining of the abdominal cavity, lies beneath the posterior fascia. It heals quickly. Some believe that the peritoneum does not require suturing, while others disagree. If the posterior fascia is securely closed, suturing the peritoneum may not contribute to the prevention of an incisional hernia. Among surgeons who choose to close the peritoneum, a continuous suture line



with *absorbable suture material* is usually preferred. Interrupted sutures can also be used for this procedure.

### FASCIA

This layer of firm, strong connective tissue covering the muscles is the main supportive structure of the body. In closing an abdominal incision, the fascial sutures must hold the wound closed and also help to resist changes in intra-abdominal pressure. Occasionally, synthetic graft material may be used when fascia is absent or weak. PROLENE\* polypropylene mesh may be used to replace abdominal wall or repair hernias when a great deal of stress will be placed on the suture line during healing. *Nonabsorbable sutures* such as PROLENE suture may be used to suture the graft to the tissue.

Fascia regains approximately 40% of its original strength in 2 months. It may take up to a year or longer to regain maximum strength. Full original strength is never regained.

The anatomic location and type of abdominal incision will influence how many layers of fascia will be sutured. The posterior fascial layer

is always closed. The anterior layer may be cut and may also require suturing. Mass closure techniques are becoming the most popular.

Most suture materials have some inherent degree of elasticity. If not tied too tightly, the suture will "give" to accommodate postoperative swelling that occurs. Stainless steel sutures, if tied too tightly, will cut like a knife as the tissue swells or as tension is placed upon the suture line. Because of the slow healing time and because the fascial suture must bear the maximum stress of the wound, a moderate size *nonabsorbable suture* may be used. An *absorbable suture* with longer lasting tensile strength, such as PDS\* II sutures, may also provide adequate support. PDS II sutures are especially well-suited for use in younger, healthy patients.

Many surgeons prefer the use of interrupted simple or figure-of-eight sutures to close fascia, while others employ running suture or a combination of these techniques. In the absence of infection or gross contamination, the surgeon may choose either *monofilament* or *multifilament* sutures. In the presence of infection, a

*monofilament absorbable material* like PDS II sutures or inert *nonabsorbable sutures* like stainless steel or PROLENE\* sutures may be used.

### MUSCLE

Muscle does not tolerate suturing well. However, there are several options in this area.

Abdominal muscles may be either cut, split (*separated*), or retracted, depending upon the location and type of the incision chosen. Where possible, the surgeon prefers to avoid interfering with the blood supply and nerve function by making a muscle-splitting incision or retracting the entire muscle toward its nerve supply. During closure, muscles handled in this manner do not need to be sutured. The fascia is sutured rather than the muscle.

*The Smead-Jones far-and-near-technique* for abdominal wound closure is strong and rapid, provides good support during early healing with a low incidence of wound disruption, and has a low incidence of late incisional problems. This is a single-layer closure through both layers of the abdominal wall fascia, abdominal muscles, peritoneum,

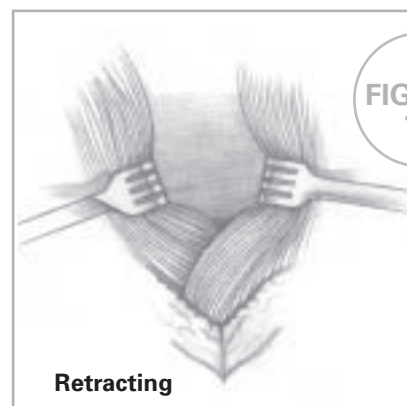
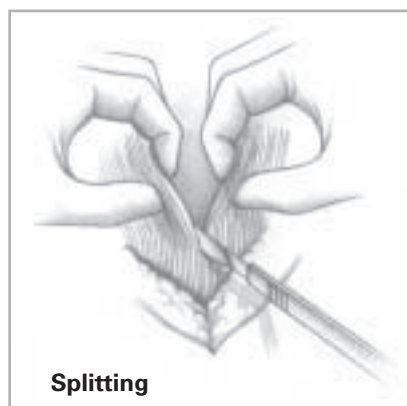
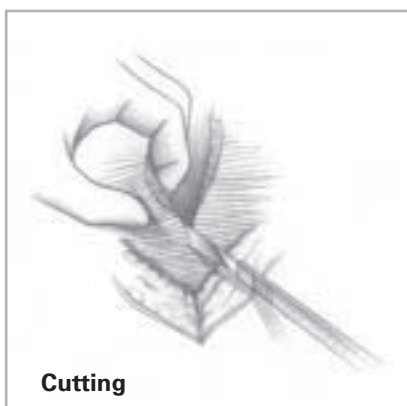

FIGURE 14

**SURGICAL  
OPTIONS IN  
MUSCLE**



and the anterior fascial layer. The interrupted sutures resemble a "figure of eight" when placed.

*Absorbable* PDS II sutures or VICRYL\* sutures are usually used.

Stainless steel sutures may also be used. *Monofilament* PROLENE sutures also provide all the advantages of steel sutures: strength, minimal tissue reactivity, and resistance to bacterial contamination. They are better tolerated than steel sutures by patients in the late postoperative months and are easier for the surgeon to handle and tie. However, both stainless steel and PROLENE sutures may be detectable under the skin of thin patients. To avoid this problem, knots should be buried in fascia instead of in the subcutaneous space.

### SUBCUTANEOUS FAT

Neither fat nor muscle tolerate suturing well. Some surgeons question the advisability of placing sutures in fatty tissue because it has little tensile strength due to its composition, which is mostly water. However, others believe it is necessary to place at least a few sutures in a thick layer of subcutaneous fat to prevent dead space, especially in obese patients. Dead spaces are most likely to occur in this type of tissue, so the edges of the wound must be carefully approximated. Tissue fluids can accumulate in these pocket-like spaces, delaying healing and predisposing infection.

*Absorbable sutures* are usually selected for the subcutaneous layer. VICRYL\* suture is especially suited for use in fatty, avascular tissue since it is absorbed by hydrolysis. The surgeon may use the same type and

size of material used earlier to ligate blood vessels in this layer.

### SUBCUTICULAR TISSUE

To minimize scarring, suturing the subcuticular layer of tough connective tissue will hold the skin edges in close approximation. In a single-layer subcuticular closure, less evidence of scar gaping or expansion may be seen after a period of 6 to 9 months than is evident with simple skin closure. The surgeon takes continuous short lateral stitches beneath the epithelial layer of skin. Either *absorbable* or *nonabsorbable sutures* may be used. If nonabsorbable material is chosen, one end of the suture strand will protrude from each end of the incision, and the surgeon may tie them together to form a "loop" or knot the ends outside of the incision.

To produce only a hair-line scar (on the face, for example), the skin can be held in very close approximation with skin closure tapes in addition to subcuticular sutures. Tapes may be left on the wound for an extended period of time depending upon their location on the body.

When great tension is not placed upon the wound, as in facial or neck surgery, very fine sizes of subcuticular sutures may be used. Abdominal wounds that must withstand more stress call for larger suture sizes.

Some surgeons choose to close both the subcuticular and epidermal layers to achieve minimal scarring. *Chromic surgical gut* and *polymeric materials*, such as MONOCRYL\* suture, are acceptable for placement within the dermis. They are capable

of maintaining sufficient tensile strength through the collagen synthesis stage of healing which lasts approximately 6 weeks. The sutures must not be placed too close to the epidermal surface to reduce extrusion. If the skin is nonpigmented and thin, a *clear or white monofilament suture* such as MONOCRYL suture will be invisible to the eye. MONOCRYL suture is particularly well-suited for this closure because, as a monofilament, it does not harbor infection and, as a synthetic absorbable suture, tissue reaction is minimized. After this layer is closed, the skin edges may then be approximated.

### SKIN

Skin is composed of the epithelium and the underlying dermis. It is so tough that a very sharp needle is essential for every stitch to minimize tissue trauma. (*See Chapter 3: The Surgical Needle.*)

Skin wounds regain tensile strength slowly. If a nonabsorbable suture material is used, it is typically removed between 3 and 10 days postoperatively, when the wound has only regained approximately 5% to 10% of its strength. This is possible because most of the stress placed upon the healing wound is absorbed by the fascia, which the surgeon relies upon to hold the wound closed. The skin or subcuticular sutures need only be strong enough to withstand natural skin tension and hold the wound edges in apposition.

The use of coated VICRYL\* *RAPIDE* suture, a rapidly absorbed synthetic suture, eliminates the need for suture removal. Coated

VICRYL *RAPIDE* suture, which is indicated for superficial closure of skin and mucosa, provides short-term wound support consistent with the rapid healing characteristics of skin. The sutures begin to fall off in 7 to 10 days, with absorption essentially complete at 42 days.

Suturing technique for skin closure may be either continuous or interrupted. Skin edges should be everted. Preferably, each suture strand is passed through the skin only once, reducing the chance of cross-contamination across the entire suture line. Interrupted technique is usually preferred.

If surgeon preference indicates the use of a nonabsorbable suture material, several issues must be considered. Skin sutures are exposed to the external environment, making them a serious threat to wound contamination and stitch abscess. The interstices of multifilament sutures may provide a haven for microorganisms. Therefore, *monofilament nonabsorbable sutures* may be preferred for skin closure. Monofilament sutures also induce significantly less tissue reaction than multifilament sutures. For cosmetic reasons, *nylon* or *polypropylene monofilament sutures* may be preferred. Many skin wounds are successfully closed with silk and polyester multifilaments as well. Tissue reaction to nonabsorbable sutures subsides and remains relatively acellular as fibrous tissue matures and forms a dense capsule around the suture. (Note, surgical gut has been known to produce tissue reaction. Coated VICRYL\* *RAPIDE* suture elicits

a lower tissue reaction than chromic gut suture due to its accelerated absorption profile.) The key to success is early suture removal before epithelialization of the suture tract occurs and before contamination is converted into infection.

#### A WORD ABOUT SCARRING (EPITHELIALIZATION)

When a wound is sustained in the skin—whether accidentally or during a surgical procedure—the epithelial cells in the basal layer at the margins of the wound flatten and move into the wound area. They move down the wound edge until they find living, undamaged tissue at the base of the wound. Then they move across the wound bed to make contact with similar cells migrating from the opposite side of the wound. They move down the suture tract after it has been embedded in the skin. When the suture is removed, the tract of the epithelial cells remains. Eventually, it may disappear, but some may remain and form keratin. A punctate scar is usually seen on the skin surface and a "railroad track" or "crosshatch" appearance on the wound may result. This is

relatively rare if the skin sutures are not placed with excessive tension and are removed by the seventh postoperative day.

The forces that create the distance between the edges of the wound will remain long after the sutures have been removed. Significant collagen synthesis will occur from 5 to 42 days postoperatively. After this time, any additional gain in tensile will be due to remodeling, or crosslinking, of collagen fibers rather than to collagen synthesis. Increases in tensile strength will continue for as long as 2 years, but the tissue will never quite regain its original strength.

#### CLOSURE WITH RETENTION SUTURES

We have already discussed the techniques involved with placing retention sutures, and using them in a secondary suture line. (See the section on *Suturing Techniques*.) Heavy sizes (0 to 5) of nonabsorbable materials are usually used for retention sutures, not for strength, but because larger sizes are less likely to cut through tissue when a sudden rise in intra-abdominal pressure occurs from vomiting, coughing,



FIGURE 15

#### THE RAILROAD TRACK SCAR CONFIGURATION

straining, or distention. To prevent the heavy suture material from cutting into the skin under stress, one end of the retention suture may be threaded through a short length of plastic or rubber tubing called a *bolster* or *bumper* before it is tied. A plastic bridge with adjustable features may also be used to protect the skin and primary suture line and permit postoperative wound management for patient comfort.

Properly placed retention sutures provide strong reinforcement for abdominal wounds, but also cause the patient more postoperative pain than does a layered closure. The best technique is to use a material with needles swaged on each end (*double-armed*). They should be placed from the inside of the wound toward the outside skin to avoid pulling potentially contaminated epithelial cells through the entire abdominal wall.

The ETHICON retention suture line includes ETHILON\* sutures, MERSILENE\* sutures, ETHIBOND\* EXCEL sutures, and PERMA-HAND\* sutures. Surgical steel sutures may also be used.

Retention sutures may be left in place for 14 to 24 days postoperatively. Three weeks is an average length of time. Assessment of the patient's condition is the controlling factor in deciding when to remove retention sutures.

#### SUTURE FOR DRAINS

If a drainage tube is placed in a hollow organ or a bladder drain is inserted, it may be secured to the wall of the organ being drained with *absorbable sutures*. The surgeon may also choose to minimize the distance between the organ and the abdominal wall by using sutures to tack the organ being drained to the peritoneum and fascia.

Sutures may be placed around the circumference of the drain, either two sutures at 12 and 6 o'clock positions, or four sutures at 12, 3, 6, and 9 o'clock positions, and secured to the skin with temporary loops. When the drain is no longer needed, the skin sutures may be easily removed to remove the drain. The opening can be left open to permit additional drainage until it closes naturally.

A drainage tube inserted into the peritoneal cavity through a stab wound in the abdominal wall usually is anchored to the skin with one or two nonabsorbable sutures. This prevents the drain from slipping into or out of the wound.

#### SUTURE NEEDS IN OTHER BODY TISSUES NEUROSURGERY

Surgeons have traditionally used an interrupted technique to close the galea and dura mater.

The tissue of the galea, similar to the fascia of the abdominal cavity, is very vascular and hemostatic. Therefore, scalp hematoma is a potential problem, and the surgeon must be certain to close well.

The dura mater is the outermost of the three meninges that protects the brain and spinal cord. It tears with ease and cannot withstand too much tension. The surgeon may drain some of the cerebrospinal fluid to decrease volume, easing the tension on the dura before closing. If it is too damaged to close, a patch must be inserted and sutured in place.

*Surgical silk* is appropriate in this area for its pliability and easy knot tying properties. Unfortunately, it elicits a significant foreign body tissue reaction. Most surgeons have switched to NUROLON\* sutures or coated VICRYL\* sutures because they tie easily, offer greater strength than surgical silk, and cause less tissue reaction. PROLENE\* sutures have also been accepted by surgeons who prefer a continuous closure technique, who must repair potentially infected wounds, or who must repair dural tears.

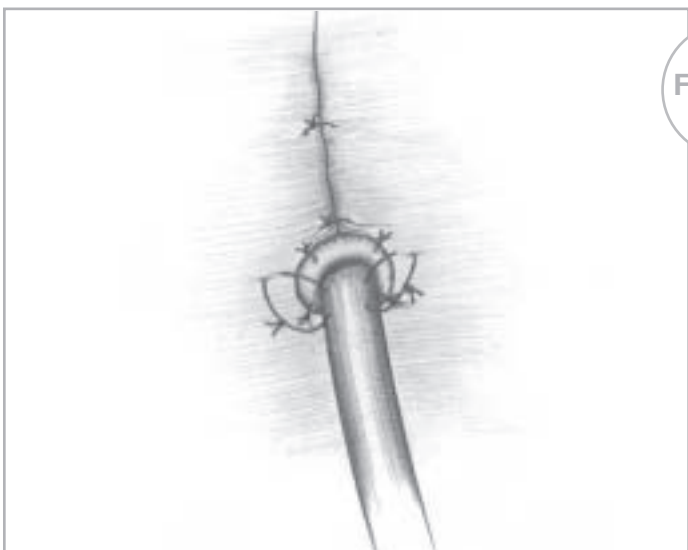

FIGURE 16

#### PLACEMENT OF SUTURES AROUND A DRAIN

In peripheral nerve repair, precise suturing often requires the aid of an operating microscope. Suture gauge and needle fineness must be consistent with nerve size. After the motor and sensory fibers are properly realigned, the epineurium (the outer sheath of the nerve) is sutured. The strength of sutures in this area is less of a consideration than the degree of inflammatory and fibroplastic tissue reaction. Fine sizes of *nylon*, *polyester*, and *poly-propylene* are preferred.

### MICROSURGERY

The introduction of fine sizes of sutures and needles has increased the use of the operating microscope. ETHICON introduced the first microsurgery sutures—ETHILON\* sutures—in sizes 8-0 through 11-0. Since then, the microsurgery line has expanded to include PROLENE\* sutures and coated VICRYL\* sutures. Literally all surgical specialties perform some procedures under the operating microscope, especially vascular and nerve anastomosis.

### OPHTHALMIC SURGERY

The eye presents special healing challenges. The ocular muscles, the conjunctiva, and the sclera have good blood supplies; but the cornea is an avascular structure. While epithelialization of the cornea occurs rapidly in the absence of infection, full thickness cornea wounds heal slowly. Therefore, in closing wounds such as cataract incisions, sutures should remain in place for approximately 21 days. Muscle recession, which involves suturing muscle to sclera, only requires sutures for approximately 7 days.

Nylon was the preferred suture material for ophthalmic surgery. While nylon is not absorbed, progressive hydrolysis of nylon *in vivo* may result in gradual loss of tensile strength over time. Fine sizes of *absorbable sutures* are currently used for many ocular procedures. Occasionally, the sutures are absorbed too slowly in muscle recessions and produce granulomas to the sclera. Too rapid absorption has, at times, been a problem in cataract surgery. Because they induce less cellular reaction than

surgical gut and behave dependably, VICRYL sutures have proven useful in muscle and cataract surgery.

While some ophthalmic surgeons promote the use of a "no-stitch" surgical technique, 10-0 coated VICRYL (polyglactin 910) violet monofilament sutures offer distinct advantages. They provide the security of suturing immediately following surgery but eliminate the risks of suture removal and related endophthalmitis.

The ophthalmologist has many fine size suture materials to choose from for keratoplasty, cataract, and vitreous retinal microsurgical procedures. In addition to VICRYL\* sutures, *other monofilament suture materials* including ETHILON sutures, PROLENE sutures, and PDS\* II sutures may be used. *Braided material* such as virgin silk, black braided silk, MERSILENE\* sutures, and coated VICRYL sutures are also available for ophthalmic procedures.

### UPPER ALIMENTARY TRACT PROCEDURES

The surgeon must consider the upper alimentary tract from the mouth down to the lower esophageal sphincter to be a potentially contaminated area. The gut is a musculomembranous canal lined with mucus membranes. Final healing of mucosal wounds appears to be less dependent upon suture material than on the wound closure technique.

The oral cavity and pharynx generally heal quickly if not infected. Fine size sutures are adequate in this area as the wound is under little tension. *Absorbable sutures* may be

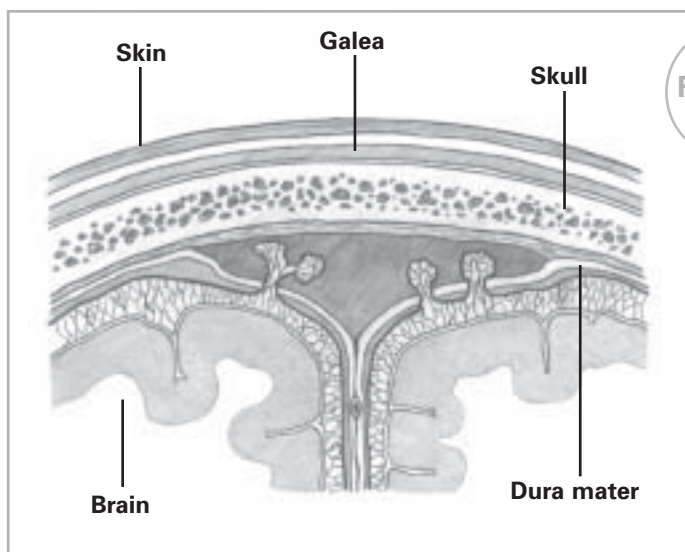

FIGURE 17

### LAYERS OF SUTURES SURROUNDING A DRAIN



preferred. Patients, especially children, usually find them more comfortable. However, the surgeon may prefer a *monofilament nonabsorbable suture* under certain circumstances. This option causes less severe tissue reaction than multifilament materials in buccal mucosa, but also requires suture removal following healing.

In cases involving severe periodontitis, VICRYL periodontal mesh may be used to promote tissue regeneration, a technique that enhances the regeneration and attachment of tissue lost due to periodontitis. VICRYL periodontal mesh, available in several shapes and sizes with a preattached VICRYL ligature, is woven from the same copolymer used to produce absorbable VICRYL\* suture. As a synthetic absorbable, VICRYL\* periodontal mesh eliminates the trauma associated with a second surgical procedure and reduces the risk of infection or inflammation associated with this procedure.

The esophagus is a difficult organ to suture. It lacks a serosal layer. The mucosa heals slowly. The thick muscular layer does not hold sutures well. If multifilament sutures are used, penetration through the mucosa into the lumen should be avoided to prevent infection.

#### RESPIRATORY TRACT SURGERY

Relatively few studies have been done on healing in the respiratory tract. Bronchial stump closure following lobectomy or pneumonectomy presents a particular challenge. Infection, long stumps, poor approximation of the transected

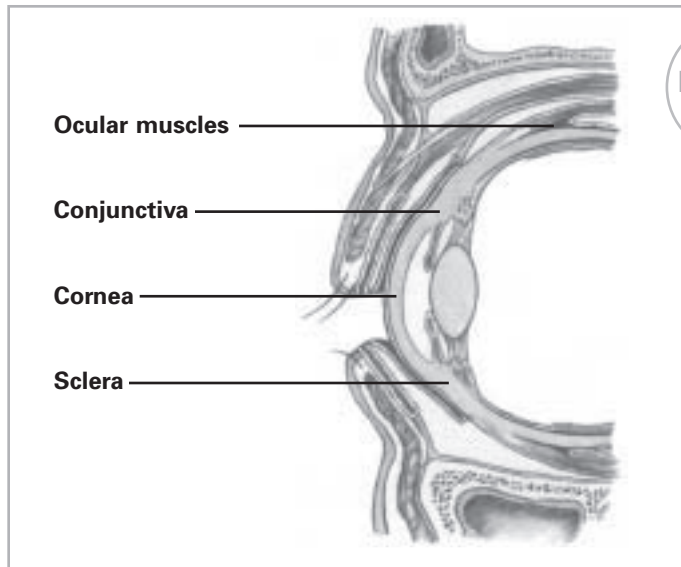

FIGURE 18

THE EYE

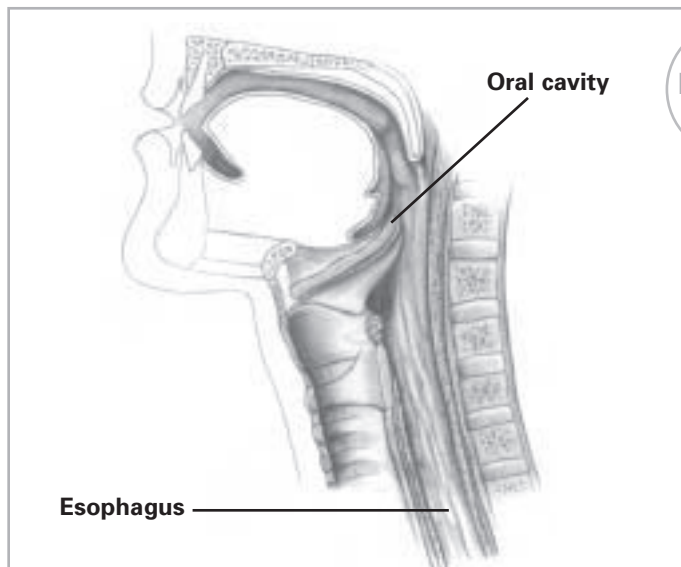

FIGURE 19

THE UPPER ALIMENTARY CANAL

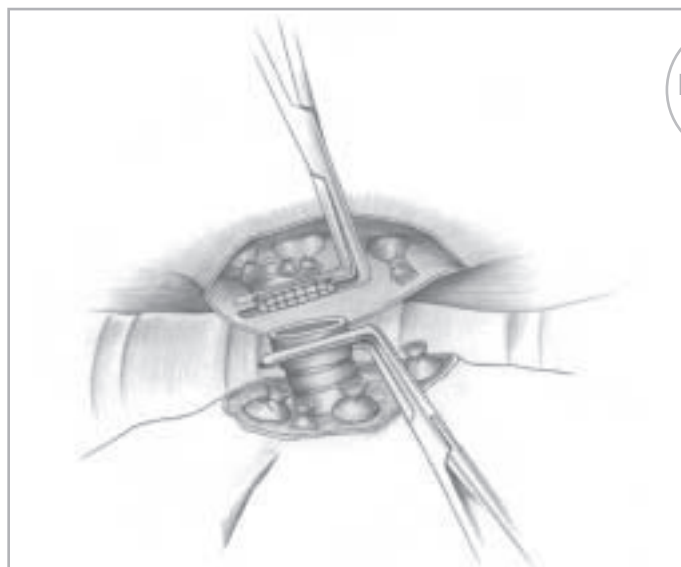

FIGURE 20

BRONCHIAL STUMP CLOSURE



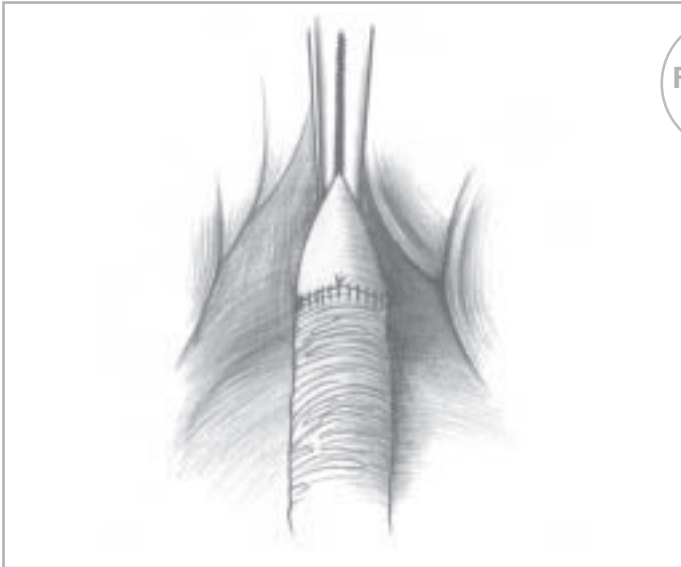

FIGURE 21

### CONTINUOUS STRAND SUTURING IN VASCULAR SURGERY

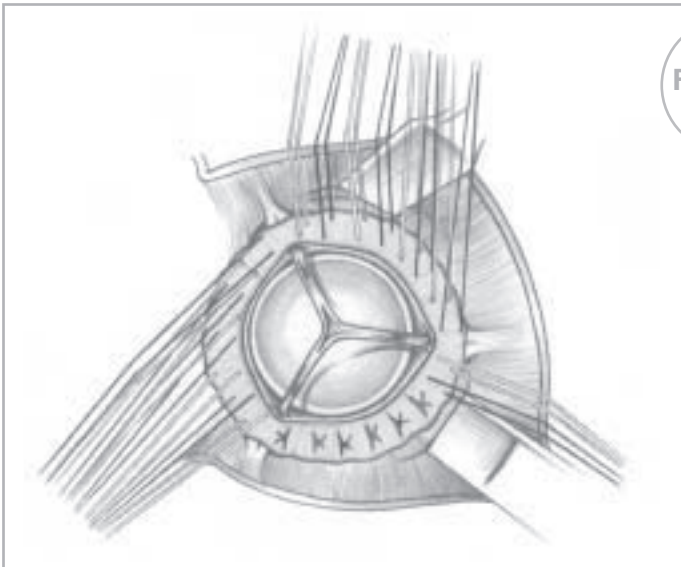

FIGURE 22

### SEATING A HEART VALVE WITH ETHIBOND EXCEL SUTURE



FIGURE 23

### THE BUNNELL TECHNIQUE

bronchus, and incomplete closure (i.e., air leaks) may lead to bronchopleural fistula. Avoidance of tissue trauma and maintenance of the blood supply to the area of closure are critical to healing. The bronchial stump heals slowly, and sometimes not at all. Unless it is closed tightly with strong, closely spaced sutures, air may leak into the thoracic cavity.

Closure is usually achieved with *mechanical devices*, particularly staples. When sutures are used, *polypropylene monofilament nonabsorbable* sutures are less likely to cause tissue reaction or harbor infection. Silk suture is also commonly used. Surgeons usually avoid absorbable sutures because they may permit secondary leakage as they lose strength.

Monofilament nylon suture should also be avoided because of its potential for knot loosening.

### CARDIOVASCULAR SURGERY

Although definitive studies are few, blood vessels appear to heal rapidly. Most cardiovascular surgeons prefer to use synthetic nonabsorbable sutures for cardiac and peripheral vascular procedures. Lasting strength and leakproof anastomoses are essential. Wire sutures are used on the sternum unless it is fragile, in which case absorbable sutures can be used.

### VESSELS

Excessive tissue reaction to suture material may lead to decreased luminal diameter or to thrombus formation in a vessel. Therefore, the more inert synthetics including *nylon* and *polypropylene* are the materials of choice for vessel

anastomoses. *Multifilament polyester sutures* allow clotting to occur within the interstices which helps to prevent leakage at the suture line. The advantages of a material such as ETHIBOND\* *EXCEL* sutures are its strength, durability, and slippery surface which causes less friction when drawn through a vessel. Many surgeons find that PROLENE\* sutures, PRONOVA\* sutures, or silk are ideal for coronary artery procedures because they do not "saw" through vessels.

Continuous sutures provide a more leakproof closure than interrupted sutures in large vessel anastomoses because the tension along the suture strand is distributed evenly around the vessel's circumference. Interrupted *monofilament sutures* such as ETHILON\* sutures, PROLENE\* sutures, or PRONOVA\* sutures are used for microvascular anastomoses. When anastomosing major vessels in young children, special care must be taken to anticipate the future growth of the patient. Here, the surgeon may use silk to its best advantage, because it loses much of its tensile strength after approximately 1 year, and is usually completely absorbed after 2 or more years. Continuous *polypropylene sutures* have been used in children without adverse effects. The continuous suture, when placed, is a coil which stretches as the child grows to accommodate the changing dimensions of the blood vessel. However, reports of stricture following vessel growth have stimulated interest in use of a suture line which is one-half continuous, one-half interrupted.

Clinical studies suggest that a *prolonged absorbable suture*, such as PDS\* II suture, may be ideal, giving adequate short-term support while permitting future growth.

Following vascular trauma, mycotic aneurysms from infection are extremely serious complications. A suture may act as a nidus for an infection. In the presence of infection, the chemical properties of suture material can cause extensive tissue damage which may reduce the tissue's natural ability to combat infection. Localized sepsis can also spread to adjacent vascular structures, causing necrosis of the arterial wall. Therefore, the surgeon may choose a *monofilament suture material* that causes only a mild tissue reaction and resists bacterial growth.

#### VASCULAR PROSTHESES

The fixation of vascular prostheses and artificial heart valves presents an entirely different suturing challenge than vessel anastomosis. The sutures must retain their original physical properties and strength throughout the life of the patient. A prosthesis never becomes completely incorporated into the tissue and constant movement of the suture line occurs. *Coated polyester sutures* are the choice for fixation of vascular prostheses and heart valves because they retain their strength and integrity indefinitely.

Either a continuous or interrupted technique may be used for vessel to graft anastomoses.

To assist in proper strand identification, many surgeons alternate green and white strands of ETHIBOND\*

*EXCEL* suture around the cuff of the valve before tying the knots.

Some surgeons routinely use pledgets to buttress sutures in valve surgery. They are used most commonly in valve replacement procedures to prevent the annulus from tearing when the prosthetic valve is seated and the sutures are tied. They may also be used in heart wall closure of penetrating injuries, excising aneurysms, vascular graft surgery, and to add support when the surgeon encounters extreme deformity, distortion, or tissue destruction at the annulus.

#### URINARY TRACT SURGERY

Closure of tissues in the urinary tract must be leakproof to prevent escape of urine into surrounding tissues. The same considerations that affect the choice of sutures for the biliary tract affect the choice of sutures for this area. Nonabsorbable sutures incite the formation of calculi, and therefore cannot be used. Surgeons use *absorbable sutures* as a rule, especially MONOCRYL\* sutures, PDS II sutures, VICRYL\* sutures, Coated VICRYL\* sutures, and chromic gut sutures.

The urinary tract heals rapidly. The transitional cell epithelium migrates over the denuded surfaces quickly. Unlike other epithelium, the migrating cells in the urinary tract undergo mitosis and cell division. Epithelial migration may be found along suture tracts in the body of the bladder. The bladder wall regains 100% of its original tensile strength within 14 days. The rate of collagen synthesis peaks at 5 days and declines rapidly thereafter.

Thus, sutures are needed for only 7 to 10 days.

### THE FEMALE GENITAL TRACT

Surgery within this area presents certain challenges. First, it is usually regarded as a potentially contaminated area. Second, the surgeon must frequently work within a very restricted field. Endoscopic technique is frequently used in this area. Coated VICRYL\* suture is an excellent choice to prevent bacterial colonization.

Most gynecological surgeons prefer to use *absorbable sutures* for repair of incisions and defects. Some prefer using heavy, size 1 surgical gut sutures, MONOCRYL sutures, or VICRYL sutures. However, the stresses on the reproductive organs and the rate of healing indicate that these larger-sized sutures may only be required for abdominal closure.

Handling properties, especially pliability of the sutures used for internal use, are extremely important. *Synthetic absorbable sutures* such as VICRYL\* sutures in size 0 may be used for the tough, muscular, highly vascular tissues in the pelvis and vagina. These tissues demand strength during approximation and healing. Coated VICRYL\* *RAPIDE* suture, for example, is an excellent choice for episiotomy repair.

### TENDON SURGERY

Tendon surgery presents several challenges. Most tendon injuries are due to trauma, and the wound may be dirty. Tendons heal slowly. The striated nature of the tissue makes suturing difficult.

Tendon repair fibroblasts are derived from the peritendonous

tissue and migrate into the wound. The junction heals first with scar tissue, then by replacement with new tendon fibers. Close apposition of the cut ends of the tendon (especially extensor tendons) must be maintained to achieve good functional results. Both the suture material and the closure technique are critical for successful tendon repair.

The suture material the surgeon chooses must be inert and strong. Because tendon ends can separate due to muscle pull, sutures with a great degree of elasticity should be avoided. *Surgical steel* is widely used because of its durability and lack of elasticity. *Synthetic nonabsorbable materials* including polyester fibers, polypropylene, and nylon may be used. In the presence of potential infection, the most inert monofilament suture materials are preferred. The suture should be placed to cause the least possible interference with the surface of the tendon, as this is the gliding mechanism. It should also not interfere with the blood supply reaching the wound. Maintenance of closed apposition of the cut ends of the tendons, particularly extensor tendons, is critical for good functional results. The parallel arrangement of tendon fibers in a longitudinal direction makes permanent and secure placement of sutures difficult. Various figure-of-eight and other types of suturing have been used successfully to prevent suture slippage and the formation of gaps between the cut ends of the tendon.

Many surgeons use the Bunnell Technique. The suture is placed to be withdrawn when its function as a

holding structure is no longer necessary. Referred to as a *pull-out suture*, it is brought out through the skin and fastened over a polypropylene button. The Bunnell Technique suture can also be left in place.

NUROLON\* sutures, PROLENE\* sutures, PRONOVA\* sutures and ETHIBOND\* *EXCEL* sutures may be used for connecting tendon to bone. Permanent wire sutures also yield good results because healing is slow. In periosteum, which heals fairly rapidly, surgical gut or coated VICRYL sutures may be used. In fact, virtually any suture may be used satisfactorily in the periosteum.

### SUTURES FOR BONE

In repairing facial fractures, *monofilament surgical steel* has proven ideal for its lack of elasticity. Facial bones do not heal by callus formation, but more commonly by fibrous union. The suture material must remain in place for a long period of time—perhaps months—until the fibrous tissue is laid down and remodeled. Steel sutures immobilize the fracture line and keep the tissues in good apposition.

Following median sternotomy, surgeons prefer interrupted steel sutures to close. Sternum closure may be difficult. Appropriate tension must be maintained, and the surgeon must guard against weakening the wire. Asymmetrical twisting of the wire may cause it to buckle, fatiguing the metal, and ultimately causing the wire to break. Motion between the sides of the sternum will result, causing postoperative pain and possibly dehiscence. Painful nonunion is another possible complication. (In osteoporotic patients, very heavy

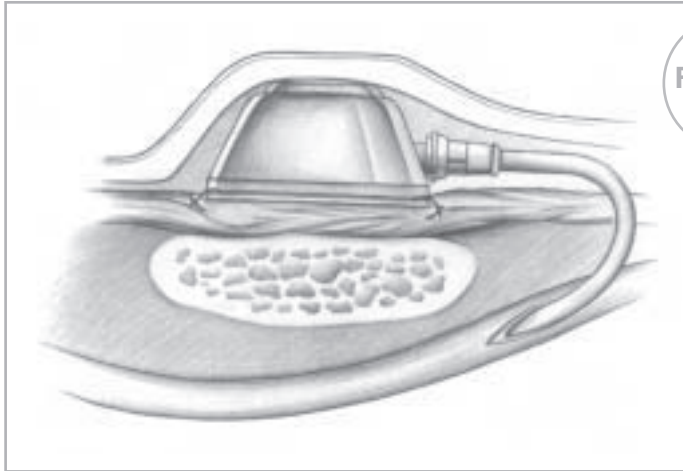

**FIGURE  
24**

**TACKING A  
PROSTHETIC  
DEVICE IN  
POSITION TO  
PREVENT  
MIGRATION**

VICRYL sutures may be used to close the sternum securely.)

The surgeon may use a bone anchor to hold one end of a suture in place when needed (e.g., shoulder repair surgery). This involves drilling a hole in the bone and inserting the anchor, which expands once completely inside the bone to keep it from being pulled out.

#### **OTHER PROSTHETIC DEVICES**

Often, it is necessary for the surgeon to implant a prosthetic device such as an automatic defibrillator or drug delivery system into a patient. To prevent such a device from migrating out of position, it may be tacked to the fascia or chest wall with nonabsorbable sutures.

#### **CLOSING CONTAMINATED OR INFECTED WOUNDS**

Contamination exists when microorganisms are present, but in insufficient numbers to overcome the body's natural defenses. Infection exists when the level of contamination exceeds the tissue's ability to defend against the invading microorganisms. Generally, contamination becomes infection

when it reaches approximately  $10^6$  bacteria per gram of tissue in an immunologically normal host. Inflammation without discharge and/or the presence of culture-positive serous fluid indicate possible infection. Presence of purulent discharge indicates positive infection.

Contaminated wounds can become infected when hematomas, necrotic tissue, devascularized tissue, or large amounts of devitalized tissue (especially in fascia, muscle, and bone) are present. Microorganisms multiply rapidly under these conditions, where they are safe from cells that provide local tissue defenses.

In general, contaminated wounds should not be closed but should be left open to heal by secondary intention because of the risk of infection. Foreign bodies, including sutures, perpetuate localized infection. Therefore, the surgeon's technique and choice of suture is critical. *Nonabsorbable monofilament nylon sutures* are commonly used in anticipation of delayed closure of dirty and infected wounds. The sutures are laid in but not tied. Instead, the loose suture ends are held in place with PROXI-STRIP\* skin

closures (sterile tape). The wound should be packed to maintain a moist environment. When the infection has subsided, the surgeon can easily reopen the wound, remove the packing and any tissue debris, and then close using the previously inserted monofilament nylon suture.

## **IN THE NEXT SECTION**

The surgeon depends as much upon the quality and configuration of the needle used as on the suturing material itself to achieve a successful closure. The relationship between needles and sutures will be explored on the pages that follow.

#### **REFERENCES**

1. Mangram AJ, Horan TC, Pearson ML, Silver LC, Jarvis WR. Guideline for prevention of surgical site infection, 1999. *Infection Control and Hospital Epidemiology*. 1999;20:247-278.
2. Gilbert P, McBain AJ, Storch ML, Rothenburger SJ, Barbolt TA. Literature-based evaluation of the potential risks associated with impregnation of medical devices and implants with triclosan. *Surg Infection J*. 2002;3(suppl1):S55-S63.
3. Rothenburger S, Spangler D, Bhende S, Burkley D. In vitro antibacterial evaluation of Coated VICRYL\* Plus Antibacterial suture (coated polyglactin 910 with triclosan) using zone of inhibition assays. *S Infection J*. 2002;3(suppl 1):S79-S87.



# THE SURGICAL NEEDLE





Necessary for the placement of sutures in tissue, surgical needles must be designed to carry suture material through tissue with minimal trauma. They must be sharp enough to penetrate tissue with minimal resistance. They should be rigid enough to resist bending, yet flexible enough to bend before breaking. They must be sterile and corrosion-resistant to prevent introduction of microorganisms or foreign bodies into the wound.

Comfort with needle security in the needleholder, the ease of passage through tissue, and the degree of trauma that it causes all have an impact upon the overall results of surgical needle performance. This is especially true when precise cosmetic results are desired.

#### The best surgical needles are:

- Made of high quality stainless steel.
- As slim as possible without compromising strength.
- Stable in the grasp of a needleholder.
- Able to carry suture material through tissue with minimal trauma.
- Sharp enough to penetrate tissue with minimal resistance.
- Rigid enough to resist bending, yet ductile enough to resist breaking during surgery.
- Sterile and corrosion-resistant to prevent introduction of microorganisms or foreign materials into the wound.

Variations in needle geometries are just as important as variations in suture sizes. Needle dimensions must be compatible with suture sizes, allowing the two to work in tandem.

## ELEMENTS OF NEEDLE DESIGN

Needle design involves analyzing a surgical procedure and the density of the tissue involved in great detail. ETHICON engineers work continuously to improve upon their needle line, sometimes making subtle alterations resulting in a positive impact upon the procedure itself.

The anatomy of the ideal surgical needle has three key factors that make up the ideal needle.

- Alloy
- Geometry – tip and body
- Coating

The combination of these attributes is ETHICON MultiPass Needle Technology.

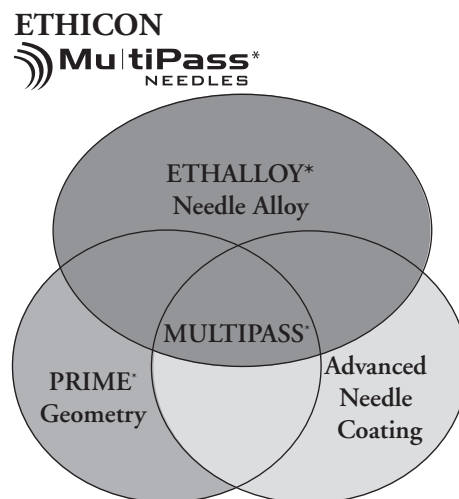

MultiPass needles are the highest performing needles that ETHICON Products offers; comprised of three proprietary technologies which

ensure superior strength, tissue penetration and control; pass after pass.

- ◆ **NEW Advanced Needle Coating**—new silicone coating helps to maintain needle sharpness pass after pass and consistency from needle to needle
- ◆ **PRIME Needle Geometry**—needles have less mass and require less penetration force to minimize tissue trauma
- ◆ **ETHALLOY Needle Alloy**—provides superior strength and ductility (bending without breaking)

The various metal alloys used in the manufacture of surgical needles determine their basic characteristics to a great degree. ETHICON\* stainless steel alloy needles are heat-treated to give them the maximum possible strength and ductility. ETHALLOY\* needle alloy (Patent No. 5,000,912) was developed for unsurpassed strength in precision needles used in cardiovascular, ophthalmic, plastic, and microsurgical procedures. It is produced economically without sacrificing ductility or corrosion resistance.

A needle's *strength* is determined by how it resists deformation during repeated passes through tissue. Tissue trauma can be induced if a needle bends during penetration and compromises tissue apposition. Therefore, greater needle strength equals less tissue trauma. A weak needle that bends too easily can compromise the surgeon's control and damage surrounding tissue during the procedure. In addition, loss of control in needle placement could result in an inadvertent needlestick.

Manufacturers measure needle strength in the laboratory by bending them 90° to determine the needle's maximum strength. This is referred to as the needle's "ultimate moment," and is more important to the needle manufacturer than to the surgeon. The most critical aspect of needle strength to the surgeon is the "surgical yield" point. Surgical yield indicates the amount of angular deformation the needle can withstand before becoming permanently deformed. This point is usually 10° to 30° depending upon the material and the manufacturing process. Any angle beyond that point renders the needle useless. Reshaping a bent needle may cause it to lose strength and be less resistant to bending and breaking.

At ETHICON, the combination of alloy selection and the needle manufacturing process are carefully

selected to achieve the highest possible surgical yield, which also optimizes needle strength.

*Ductility* refers to the needle's resistance to breaking under a given amount of bending. If too great a force is applied to a needle it may break, but a ductile needle will bend before breaking. Needle breakage during surgery can prevent apposition of the wound edges as the broken portion passes through tissue. In addition, searching for part of a broken needle can cause added tissue trauma and add to the time the patient is anesthetized. A piece that cannot be retrieved will remain as a constant reminder to both the patient and surgeon. Needle bending and breakage can be minimized by carefully passing needles through tissue in the direction of the needle body. Needles are not designed to be used as retractors to lift tissue.

Needle *sharpness* is especially important in delicate or cosmetic surgery. The sharper the needle, the less scarring that will result. However, the right balance must be found. If a needle is too sharp, a surgeon may not feel he or she has adequate control of needle passage through tissue.

Sharpness is related to the angle of the point as well as the taper ratio of the needle. The ETHICON sharpness tester incorporates a thin, laminated, synthetic membrane that simulates the density of human tissue, allowing engineers to gauge exactly how much force is required for penetration.

MultiPass needles have a micro-thin coating comprised of a patented silicone formulation that improves penetration performance over multiple passes. According to laboratory tests, this coating serves several important functions:

- ◆ It reduces the force needed to make initial penetration through tissue; thus it is 58% sharper (than other surgical needles) on multiple passes in human tissue
- ◆ Significantly improves the consistency of the needle penetration (pass to pass, needle to needle)
- ◆ Maintains sharpness for better penetration and control over multiple passes while delivering ongoing strength, sharpness and control

Needle performance is also influenced by the stability of the needle in the grasp of a needleholder. Most curved needles are flattened in the grasping area to enhance control. All ETHICON

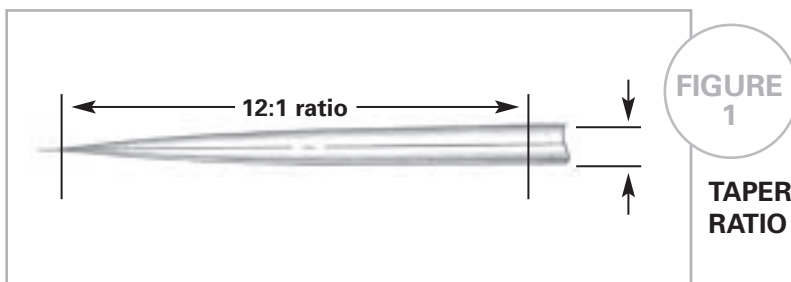

FIGURE  
1

TAPER  
RATIO



FIGURE  
2

ETHICON  
RIBBED  
NEEDLE

curved needles of 22 mil wire or heavier are ribbed as well as flattened. Longitudinal ribbing or grooves on the inside or outside curvatures of curved needles provides a crosslocking action in the needleholder for added needle control. This reduces undesirable rocking, twisting, and turning in the needleholder.

## PRINCIPLES OF CHOOSING A SURGICAL NEEDLE

While there are no hard and fast rules governing needle selection, the following principles should be kept in mind. (*Specific types of needles mentioned here will be described in full detail later on in this section.*)

1. Consider the tissue in which the surgeon will introduce the needle. Generally speaking, taper point needles are most often used to suture tissues that are easy to penetrate. Cutting or TAPERCUT\* needles are more often used in tough, hard-to-penetrate tissues. When in doubt about whether to choose a taper point or cutting needle, choose the taper point for everything except skin sutures.
2. Watch the surgeon's technique closely. Select the length, diameter, and curvature of the needle according to the desired placement of the suture and the space in which the surgeon is working.
3. Consult frequently with the surgeon. Working with the same surgeon repeatedly leads to familiarity with his or her individual routine. However, even the same surgeon may need to change needle type or size to meet specific requirements, even during a single operative procedure.
4. When using eyed needles, try to match needle diameter to suture size. Swaged needles, where the needle is already attached to the suture strand, eliminate this concern.
5. The best general rule of thumb for the scrub person to follow is pay attention and remain alert to the progress of the operation.

Observation is the best guide to needle selection if the surgeon has no preference.

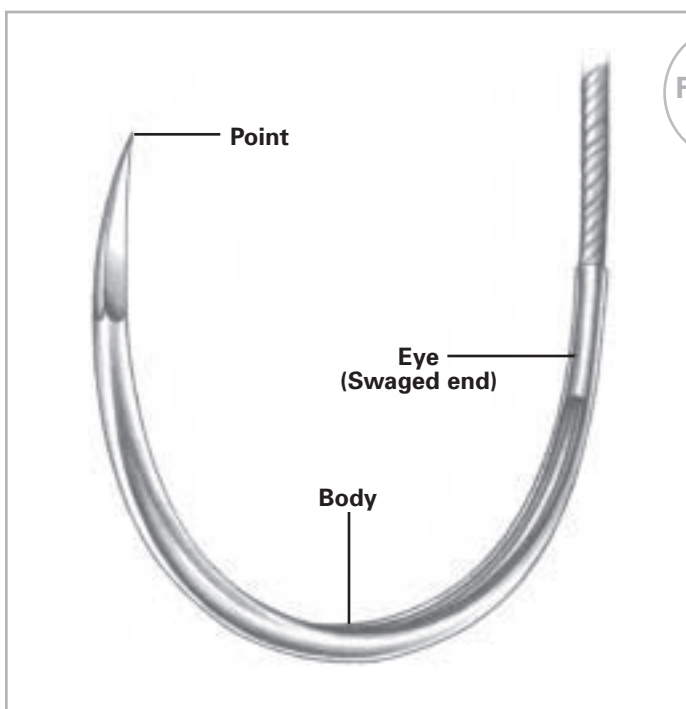

FIGURE 3

### NEEDLE COMPONENTS

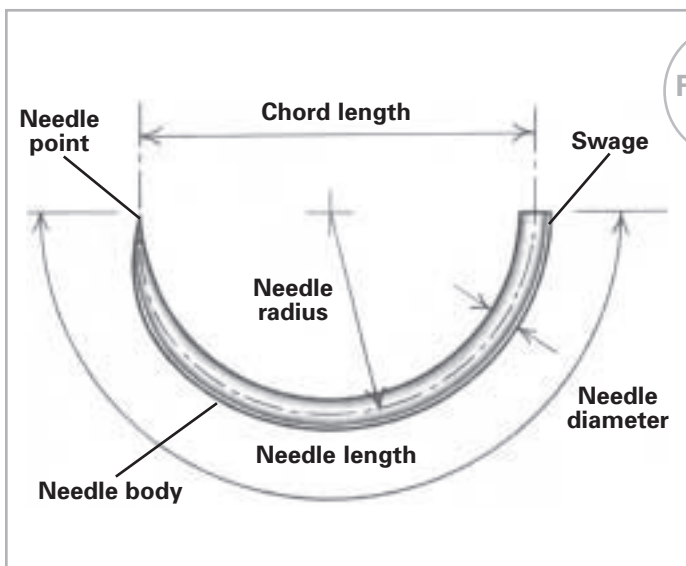

FIGURE 4

### ANATOMY OF A NEEDLE

## THE ANATOMY OF A NEEDLE

Regardless of its intended use, every surgical needle has three basic components:

- ◆ The eye.
- ◆ The body.
- ◆ The point.

The measurements of these specific components determine, in part, how they will be used most efficiently.

Needle size may be measured in inches or in metric units. The following measurements determine the size of a needle.

- ◆ **CHORD LENGTH**—The straight line distance from the point of a curved needle to the swage.
- ◆ **NEEDLE LENGTH**—The distance measured along the needle itself from point to end.
- ◆ **RADIUS**—The distance from the center of the circle to the body of the needle if the curvature of the needle were continued to make a full circle.
- ◆ **DIAMETER**—The gauge or thickness of the needle wire. Very small needles of fine gauge are needed for microsurgery. Large, heavy gauge needles are used to penetrate the sternum and to place retention sutures in the abdominal wall. A broad spectrum of sizes are available between the two extremes.

### THE NEEDLE EYE

The eye falls into one of three categories: closed eye, French (split or spring) eye, or swaged (eyeless).

The closed eye is similar to a household sewing needle. The shape of the eye may be round, oblong, or square. French eye needles have a slit from inside the eye to the end of the needle with ridges that catch and hold the suture in place.

Eyed needles must be threaded, a time-consuming procedure for the scrub person. This presents the disadvantage of having to pull a double strand of suture material through tissue, creating a larger hole with additional tissue disruption. In addition, the suture may still become unthreaded while the surgeon is using it. While tying the suture to the eye may minimize this possibility, it also adds to the bulk of the suture. Another disadvantage of eyed needles is that repeated use of these needles with more than one suture strand causes the needle to become dull, thereby making suturing more difficult.

Virtually all needles used today are swaged. This configuration joins the needle and suture together as a continuous unit—one that is convenient to use and minimizes trauma. The method of attaching the suture to the needle varies with the needle diameter. In larger diameter needles, a hole is drilled in the needle end. In smaller diameter needles, a channel is made by forming a "U" at the swage end or a hole is drilled in the wire with a laser. Each hole or channel is specifically engineered for the type and size of suture material it will hold, and crimped or closed around the suture to hold it securely. When the surgeon has finished placing the suture line in the patient's tissue, the suture may

be cut, or easily released from the needle as is the case when using CONTROL RELEASE\* needles (Patent No. 3,980,177).

The diameter of a needle swaged to suture material is no larger than necessary to accommodate the diameter of the suture strand itself. Swaged sutures offer several advantages to the surgeon, nurse, and patient.

1. The scrub person does not have to select a needle when the surgeon requests a specific suture material since it is already attached.
2. Handling and preparation are minimized. The strand with needle attached may be used directly from the packet. This helps maintain the integrity of the suture strand.
3. Tissues are subjected to minimal trauma.
4. Tissue trauma is further reduced because a new, sharp, undamaged needle is provided with each suture strand.
5. Swaged sutures do not unthread prematurely.
6. If a needle is accidentally dropped into a body cavity, the attached suture strand makes it easier to find.
7. Inventory and time spent cleaning, sharpening, handling, and sterilizing reusable eyed needles is eliminated, thereby reducing cost as well as risk of needle punctures.
8. CONTROL RELEASE needles allow placement of many sutures rapidly. This may reduce

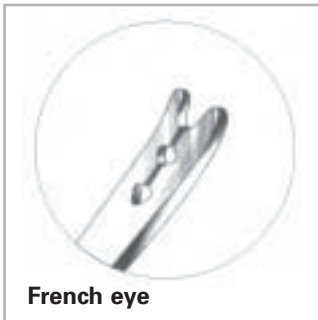

**THE NEEDLE EYE****FIGURE 5****Closed eye****French eye****Swaged**

operating time and, ultimately, the length of time the patient is anesthetized.

9. The ATRALOC\* surgical needle and CONTROL RELEASE needle ensure consistent quality and performance.
10. Swaged sutures eliminate suture fraying or damage due to sharp corners in the eye of eyed needles.
11. Needles are corrosion-free.

Small diameter ETHICON taper point needles commonly used in cardiovascular surgery were

compared in laboratory tests—some with "split" channels and some with laser-drilled holes. The needles with laser-drilled holes produced less drag force as they passed through a membrane that simulated vascular tissue. This could be associated with less trauma to the vessel walls.

The swaged ATRALOC surgical needles made by ETHICON are supplied in a variety of sizes, shapes, and strengths. Some of them incorporate the CONTROL RELEASE needle suture principle which facilitates fast separation of the needle from the suture when desired by the surgeon. This feature allows rapid placement of many sutures, as in interrupted suturing techniques. Even though the suture is securely fastened to the needle, a slight, straight tug

will release it. This needle/suture configuration was created originally for abdominal closure and hysterectomies, but is now used in a wide variety of procedures.

**THE NEEDLE BODY**

The body of the needle is the portion which is grasped by the needleholder during the surgical procedure. The body of the needle should be as close as possible to the diameter of the suture material to minimize bleeding and leakage. This is especially true for cardiovascular, gastrointestinal, and bladder procedures.

The curvature of the needle body may come in a variety of different shapes. Each shape gives the needle different characteristics.

**STRAIGHT NEEDLE**

This shape may be preferred when

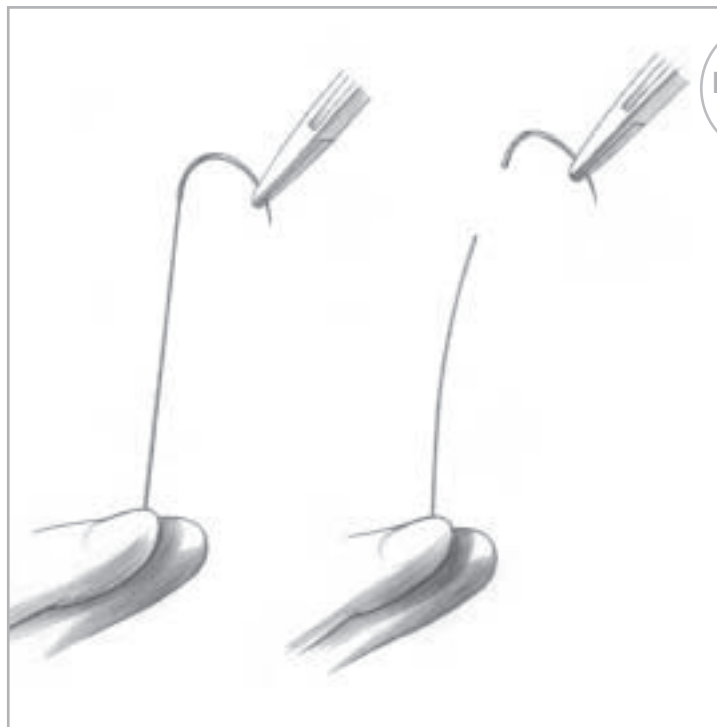
**FIGURE 6****CONTROL RELEASE NEEDLE SUTURE**

Holding the needle securely in the needleholder, the suture should be grasped securely and pulled straight and taut. The needle will be released with a straight tug of the needleholder.



suturing easily accessible tissue. Most of these needles are designed to be used in places where direct finger-held manipulation can easily be performed.

The Keith needle is a straight cutting needle. It is used primarily for skin closure of abdominal wounds. Varying lengths are also used for arthroscopic suturing of the meniscus in the knee.

Bunnell (BN) needles are used for tendon repair. Taper point needle variations may also be used for

suturing the gastrointestinal tract.

Some microsurgeons prefer straight needles for nerve and vessel repair. In ophthalmology, the straight transchamber needle protects endothelial cells and facilitates placement of intraocular lenses.

**HALF-CURVED NEEDLE**

The half-curved or "ski" needle may be used for skin closure or in laparoscopy. Its low profile allows easy passage down laparoscopic trocars. Its use in skin closure is

limited because, while the curved portion passes through tissue easily, the remaining straight portion of the body is unable to follow the curved path of the needle without bending or enlarging its path in the tissue.







**CURVED NEEDLE**

Curved needles allow predictable needle turnout from tissue, and are therefore used most often. This needle shape requires less space for maneuvering than a straight needle, but the curve necessitates manipulation with a needleholder. The curvature may be 1/4, 3/8, 1/2, or 5/8 circle. The most common use for the 3/8 circle is skin closure. The surgeon can easily manipulate this curvature with slight pronation of the wrist in a relatively large and superficial wound. It is very difficult to use this needle in a deep body cavity or restricted area because a larger arc of manipulation is required.

The 1/2 circle needle was designed for use in a confined space, although it requires more pronation and supination of the wrist. But even the tip of this needle may be obscured by tissue deep in the pelvic cavity. A 5/8 circle needle may be more useful in this situation, especially in some anal, urogenital, intraoral, and cardiovascular procedures.

**COMPOUND CURVED NEEDLE**

The compound curved needle (Patent No. 4,524,771) was originally developed for anterior segment ophthalmic surgery. It allows the surgeon to take precise,

SHAPE	APPLICATION
Straight 	gastrointestinal tract, nasal cavity, nerve, oral cavity, pharynx, skin, tendon, vessels
Half-curved 	skin (rarely used) laparoscopy
1/4 Circle 	eye (primary application) microsurgery
3/8 Circle 	aponeurosis, biliary tract, cardiovascular system, dura, eye, gastrointestinal tract, muscle, myocardium, nerve, perichondrium, periosteum, pleura, skin, tendon, urogenital tract, vessels
1/2 Circle 	biliary tract, cardiovascular system, eye, fascia, gastrointestinal tract, muscle, nasal cavity, oral cavity, pelvis, peritoneum, pharynx, pleura, respiratory tract, skin, tendon, subcutaneous fat, urogenital tract
5/8 Circle 	anal (hemorrhoidectomy), nasal cavity, pelvis, urogenital tract (primary application)
Compound Curved 	eye (anterior segment) laparoscopy

**FIGURE 7**

**NEEDLE SHAPES AND TYPICAL APPLICATIONS**

uniform bites of tissue. The tight 80° curvature of the tip follows into a 45° curvature throughout the remainder of the body. The initial curve allows reproducible, short, deep bites into the tissue. The curvature of the remaining portion of the body forces the needle out of the tissue, everting the wound edges and permitting a view into the wound. This ensures equidistance of the suture material on both sides of the incision. Equalized pressure on both sides of the corneal-scleral junction minimizes the possibility of astigmatism following anterior segment surgery.

## THE NEEDLE POINT

The point extends from the extreme tip of the needle to the maximum cross-section of the body. Each needle point is designed and produced to the required degree of sharpness to smoothly penetrate specific types of tissue.

## TYPES OF NEEDLES

### CUTTING NEEDLES

Cutting needles have at least two opposing cutting edges. They are sharpened to cut through tough, difficult-to-penetrate tissue.

Cutting needles are ideal for skin sutures that must pass through dense, irregular, and relatively thick connective dermal tissue. Because of the sharpness of the cutting edge, care must be taken in some tissue (tendon sheath or oral mucous membrane) to avoid cutting through more tissue than desired.











SHAPE	APPLICATION
Conventional Cutting 	skin, sternum
Reverse Cutting 	fascia, ligament, nasal cavity, oral mucosa, pharynx, skin, tendon sheath
Precision Point Cutting 	skin (plastic or cosmetic)
PC PRIME* Needle 	skin (plastic or cosmetic)
MICRO-POINT* Reverse Cutting Needle 	eye
Side-Cutting Spatula 	eye (primary application), microsurgery, ophthalmic (reconstructive)
CS ULTIMA* Ophthalmic Needle 	eye (primary application)
Taper 	aponeurosis, biliary tract, dura, fascia, gastrointestinal tract, laparoscopy, muscle, myocardium, nerve, peritoneum, pleura, subcutaneous fat, urogenital tract, vessels, valve
TAPERCUT* Surgical Needle 	bronchus, calcified tissue, fascia, laparoscopy, ligament, nasal cavity, oral cavity, ovary, perichondrium, periosteum, pharynx, sternum, tendon, trachea, uterus, valve, vessels (sclerotic)
Blunt 	Blunt dissection (friable tissue), cervix (ligating incompetent cervix), fascia, intestine, kidney, liver, spleen

FIGURE 8

## NEEDLE POINTS AND BODY SHAPES AND TYPICAL APPLICATIONS

## CONVENTIONAL CUTTING NEEDLES

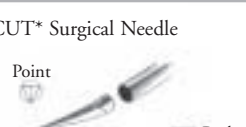
In addition to the two cutting edges, conventional cutting needles have a third cutting edge on the inside concave curvature of the needle.

The shape changes from a triangular cutting blade to that of a flattened body on both straight and curved needles. This needle type may be prone to cutout of tissue because the inside cutting edge cuts toward the edges of the incision or wound.

The PC PRIME\* needle (Precision Cosmetic, Patent No. 5,030,228) is designed specifically for aesthetic plastic surgery, and has conventional cutting edges. Where cosmetic results are important, the PC PRIME needle is superior to any other for more delicate surgery, especially facial surgery. The narrow point, fine wire diameter, and fine taper ratio allow superior penetration of soft tissue. The inside and outside curvatures of the body are flattened in the needle grasping area for greater stability in the needleholder. Fattened sides reduce bending that might occur due to the fine wire diameter.

The tip configuration of the conventional cutting sternotomy needle is slightly altered to resist bending as it penetrates the sternum. The alloy used for this needle provides the increased strength and ductility needed for its function. The cutting edges of the point extend approximately 1/4" (6mm) from the round body and terminate in a triangular-shaped tip. This particular sternotomy needle maximizes cutting efficiency and control in the needleholder. TAPERCUT surgical needles may also be used for this procedure.

## REVERSE CUTTING NEEDLES

These needles were created specifically for tough, difficult-to-penetrate tissue such as skin, tendon sheath, or oral mucosa. Reverse cutting needles are used in ophthalmic and cosmetic surgery where minimal trauma, early regeneration of tissue, and little scar formation are primary concerns. The reverse cutting needle is as sharp as the conventional cutting needle, but its design is distinctively different. The third cutting edge is located on the *outer* convex curvature of the needle. This offers several advantages:

- ◆ Reverse cutting needles have more strength than similar-sized conventional cutting needles.
- ◆ The danger of tissue cutout is greatly reduced.
- ◆ The hole left by the needle leaves a wide wall of tissue against which the suture is to be tied.

The MICRO-POINT\* surgical needle for ophthalmic procedures has a smooth surface and is honed to extreme sharpness. This allows the surgeon to suture the extremely tough tissues of the eye with optimum precision and ease.

A needle manufactured by the

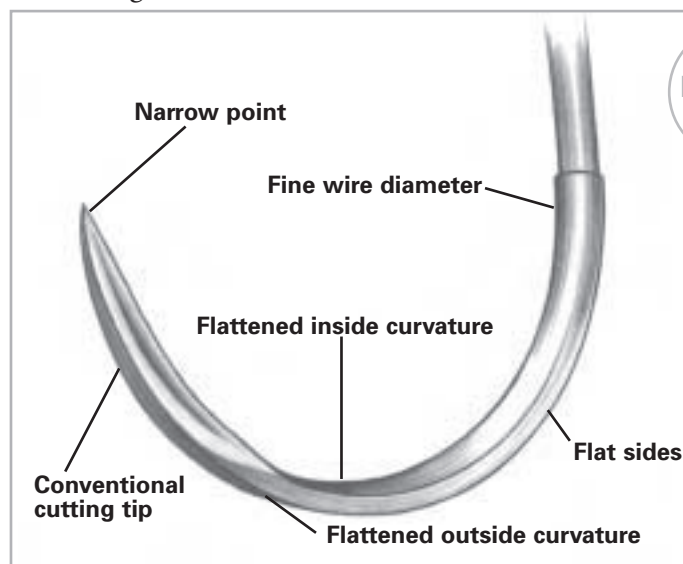

FIGURE 9

THE PC PRIME NEEDLE

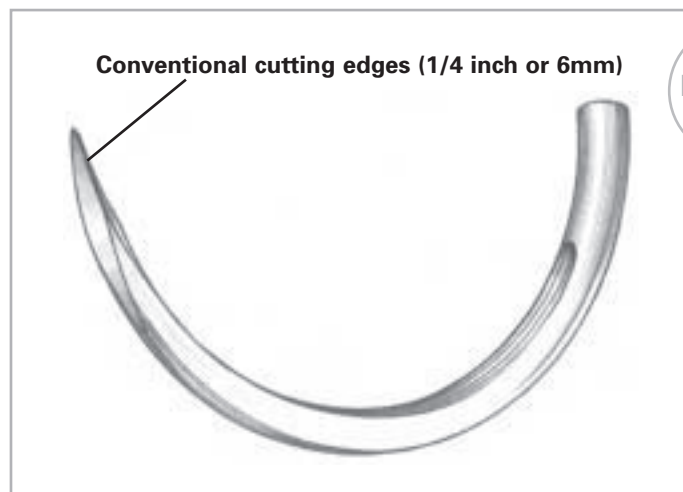

FIGURE 10

STERNOTOMY NEEDLE

exclusive ETHICON\* Precision Point Process may be used for plastic or cosmetic surgery, and passes smoothly through tissue creating a minute needle path.

This results in superior apposition. The bottom third cutting edge on the Precision Point needle flattens out as it transitions to the needle body for greater security in the needleholder.

The OS (Orthopaedic Surgery) needles are curved, heavy bodied, reverse-cutting needles. The orthopaedic surgeon may use the OS needle for extremely tough tissue, such as cartilage, where force is required for penetration.

### SIDE CUTTING NEEDLES

Also referred to as spatula needles, they feature a unique design which is flat on both the top and bottom, eliminating the undesirable tissue cutout of other cutting needles. The side-cutting edges are designed for ophthalmic procedures. They permit the needle to separate or split through the thin layers of scleral or corneal tissue and travel within the plane between them. The optimal width, shape, and precision sharpness of this needle ensure maximum ease of penetration, and gives the surgeon greater control of the needle as it passes between or through tissue layers. The position of the point varies with the design of each specific type of spatulated needle.

The SABRELOC\* spatula needle has two cutting edges and a trapezoidal-shaped body.

The SABRELOC\* needle with

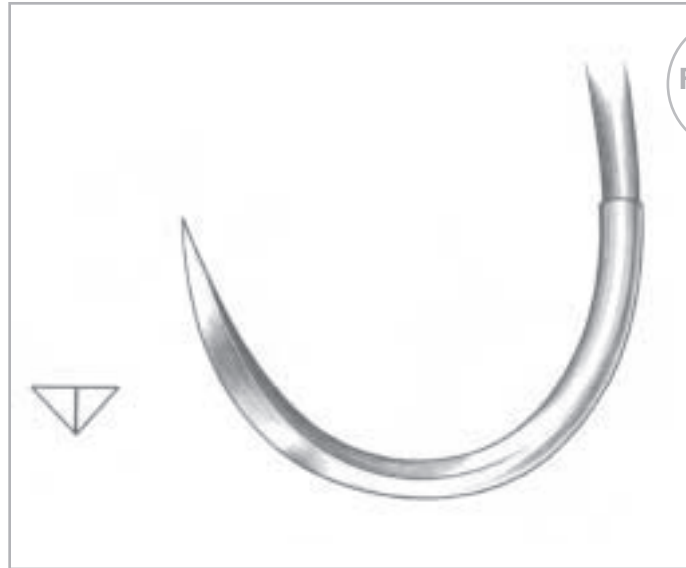

FIGURE 11

**REVERSE CUTTING NEEDLE**

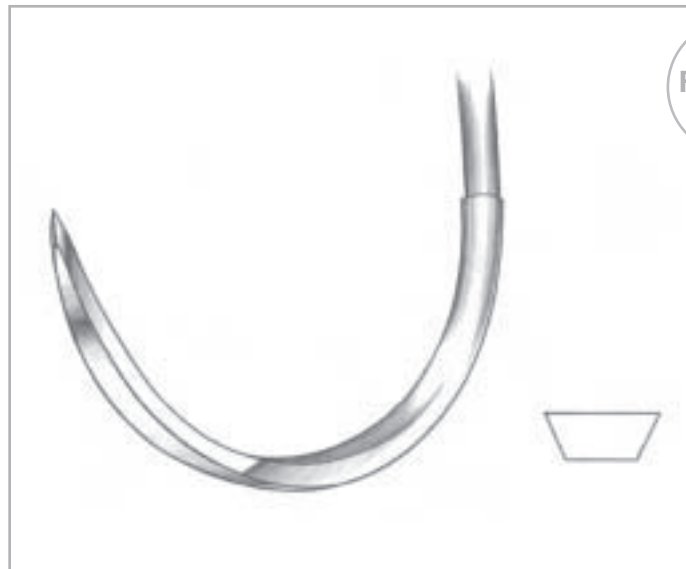

FIGURE 12

**SPATULA NEEDLE CROSS-SECTION**

the cobra-shaped tip has four equidistant defined edges.

The CS ULTIMA\* ophthalmic needle (Corneal-Scleral, Patent No. 5,002,564) is the sharpest needle in its category and is used for corneal scleral closure. The smaller angles and increased cutting-edge length result in superior sharpness facilitating easy tissue penetration.

The TG PLUS\* needle (Transverse Ground) has a long, ultra-sharp, slim tip. This needle undergoes a unique honing process which results

in a sharper needle. The surgeon encounters low penetration resistance with the TG PLUS needle, and gets excellent tactile feedback.

### TAPER POINT NEEDLES

Also referred to as *round needles*, taper point needles pierce and spread tissue without cutting it. The needle point tapers to a sharp tip. The needle body then flattens to an oval or rectangular shape. This increases the width of the body to help prevent twisting or turning in the needleholder.



Taper point needles are usually used in easily penetrated tissue such as the peritoneum, abdominal viscera, myocardium, dura, and subcutaneous layers. They are preferred when the smallest possible hole in the tissue and minimum tissue cutting are desired. They are also used in internal anastomoses to prevent leakage which can subsequently lead to contamination of the abdominal cavity. In the fascia, taper point needles minimize the potential for tearing the thin connective tissue lying between parallel and interlacing bands of denser, connective tissue.

The Mayo (MO) needle has a taper point, but a heavier and more flattened body than conventional taper needles. This needle was designed for use in dense tissue;

particularly for gynecological procedures, general closure, and hernia repair.

**TAPERCUT SURGICAL NEEDLES**

ETHICON\* manufactures TAPERCUT\* needles which combine the features of the reverse cutting edge tip and taper point needles. Three cutting edges extend approximately 1/32" back from the point. These blend into a round taper body. All three edges are sharpened to provide uniform cutting action. The point, sometimes referred to as a trocar point, readily penetrates dense, tough tissue. The objective should be for the point itself not to exceed the diameter of the suture material. The taper body portion provides smooth passage through tissue and eliminates the danger of cutting

into the surrounding tissue.

Although initially designed for use in cardiovascular surgery on sclerotic or calcified tissue, the TAPERCUT\* needle is widely used for suturing dense, fibrous connective tissue—especially in fascia, periosteum, and tendon where separation of parallel connective tissue fibers could occur with a conventional cutting needle.

ETHICON\* developed a modified TAPERCUT CC needle (Calcified Coronary) for anastomosis of small fibrotic and calcified blood vessels. The calcified portion of an artery requires a cutting tip only for initial penetration to avoid tearing the vessel. This needle configuration has a slimmer geometry than other TAPERCUT needles from the body through the point which facilitates

CODE	MEANING
BB	Blue Baby
BIF	Intraocular Fixation
BN	Bunnell
BP	Blunt Point
BV	Blood Vessel
BVH	Blood Vessel Half
C	Cardiovascular
CC	Calcified Coronary
CCS	Conventional Cutting Sternotomy
CE	Cutting Edge
CFS	Conventional for Skin
CIF	Cutting Intraocular Fixation
CP	Cutting Point
CPS	Conventional Plastic Surgery
CPX	Cutting Point Extra Large
CS	Corneal-Scleral
CSB	Corneal-Scleral Bi-Curve
CSC	Corneal-Scleral Compound Curve
CT	Circle Taper
CTB	Circle Taper Blunt
CTX	Circle Taper Extra Large
CTXB	Circle Taper Extra Large Blunt
CV	Cardiovascular
DC	Dura Closure
DP	Double Point
EN	Endoscopic Needle
EST	Eyed Straight Taper
FN	For Tonsil
FS	For Skin
FSL	For Skin Large

CODE	MEANING
FSLX	For Skin Extra Large
G	Greishaber
GS	Greishaber Spatula
J	Conjunctive
KS	Keith Straight
LH	Large Half
LR	Larger Retention
LS	Large Sternotomy
M	Muscle
MF	Modified Ferguson
MH	Medium Half (circle)
MO	Mayo
MOB	Mayo Blunt
OPS	Ocular Plastic Surgery
OS	Orthopaedic Surgery
P	Plastic
PC	Precision Cosmetic
PS	Plastic Surgery
RB	Renal (artery) Bypass
RD	Retinal Detachment
RH	Round Half (circle)
RV	Retinal-Vitreous
S	Spatula
SC	Straight Cutting
SFS	Spatulated for Skin
SH	Small Half (circle)
SIF	Ski Intraocular Fixation
SKS	Sternotomy Keith Straight
SM	Spatulated Module
ST	Straight Taper

CODE	MEANING
STB	Straight Blunt
STC	Straight Cutting
STP	Straight Taper Point
TE	Three-Eighths
TF	Tetralogy of Fallot
TG	Transverse Ground
TGW	Transverse Ground Wide
TN	Trocar Needle
TP	Taper Pericostal / Point
TPB	Taper Pericostal /Point Blunt
TS	Tendon Straight
TQ	Twisty Q
UCL	5/8 Circle Colateral Ligament
UR	Urology
URB	Urology Blunt
V	TAPERCUT Surgical Needle
VAS	Vas Deferens
X or P	Exodontal (dental)
XLH	Extra Large Half (circle)
XXLH	Extra Extra Large Half (circle)

TABLE 1

**ETHICON NEEDLE CODES & OTHER MEANING**

\* Trademark

penetration. It also minimizes the risk of leakage from friable vessels or vascular graft material.

### BLUNT POINT NEEDLES

Blunt point (BP) needles can literally dissect friable tissue rather than cutting it. They have a taper body with a rounded, blunt point that will not cut through tissue. They may be used for suturing the liver and kidney. Due to safety considerations, surgeons also use blunt point needles in obstetric and gynecological procedures when working in deep cavities which are prone to space and visibility limitations. In addition, blunt point needles for general closure are especially helpful when performing procedures on at-risk patients.

The ETHIGUARD\* blunt point needle combines the safety of the blunt point with the security of a ribbed and flattened design, and the convenience of a swaged needle.

## NEEDLEHOLDERS

The surgeon uses the needleholder to pass a curved needle through tissue. It must be made of noncorrosive, high strength, good quality steel alloy with jaws designed for holding the surgical needle securely.

Needleholder jaws may be short or flat, concave or convex, smooth or serrated. Smooth jaws may allow the needle to wobble or twist. Jaws with teeth hold most securely but may damage the suture or needle if too much pressure is applied. Most, but not all, needleholders have a ratchet lock near to thumb and finger rings.

Surgical needles are designed for

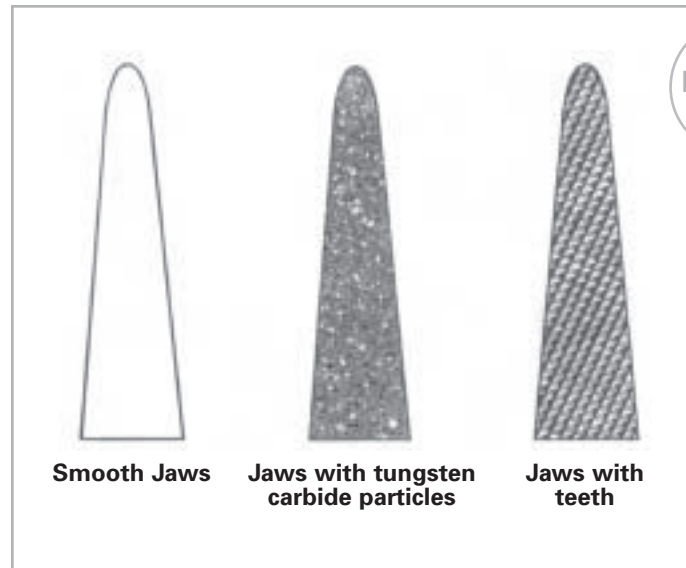

FIGURE 11

### REVERSE CUTTING NEEDLE

optimum needleholder stability. Because this tool actually drives the needle, its performance will have an impact upon the entire suturing procedure. The surgeon has maximum control only when the needle sits well in the holder without wobbling as it is passed through tissue. Needleholders, like pliers, weaken with repeated use. Therefore, the scrub person should check before each procedure to make sure that the needleholder jaws align properly and grasp securely.

When selecting a needleholder, the following should be taken into consideration:

- ◆ It must be the appropriate size for the needle selected. A very small needle should be held with small, fine jaws. The larger and heavier the needle, the wider and heavier the jaws of the needleholder should be.
- ◆ It should be an appropriate size for the procedure. If the surgeon is working deep inside the body cavity, a longer needleholder is in order.

### NEEDLEHOLDER USE

The following guidelines are offered to the scrub person for needleholder use:

1. Grasp the needle with the tip of the needleholder jaws in an area approximately one-third to one-half of the distance from the swaged end to the point. Avoid placing the holder on or near the swaged area which is the weakest part of the needle.
2. Do not grasp the needle too tightly as the jaws of the needleholder may deform, damage, or bend it irreversibly.
3. Always check alignment of the needleholder jaw to make certain the needle does not rock, twist, or turn.
4. Handle the needle and needleholder as a unit.
5. Pass the needleholder to the surgeon so that he or she will not have to readjust it before placing the suture in tissue. Make sure the needle is pointing in the direction in which it will be used and that the suture strand is

not entangled.

- Always provide a needleholder—never a hemostat—to pull the needle out through tissue. A hemostat or other clamp can damage the needle.
- Immediately after use, every needle should be returned to the scrub person while clamped in a needleholder. Needles are less likely to be lost if they are passed one-for-one (one returned for each one received).

### PLACING THE NEEDLE IN TISSUE

The actual placement of the needle in the patient's tissue can cause unnecessary trauma if done incorrectly. Keep the following in mind during suturing:

- Apply force in the tissue to be sutured in the same direction as the curve of the needle.
- Do not take excessively large bites of tissue with a small needle.
- Do not force a dull needle through tissue. Take a new needle.
- Do not force or twist the needle in an effort to bring the point out through the tissue. Withdraw the needle completely and then replace it in the tissue, or use a larger needle.
- Avoid using the needle to bridge or approximate tissues for suturing.
- Do not damage taper points or cutting edges when using the needleholder to pull the needle through tissue. Grasp as far back on the body as possible.
- Depending upon the patient, the tissue may be tougher or more

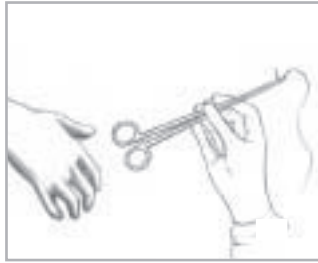

- The surgeon receives the needleholder with the needle point toward the thumb to prevent unnecessary wrist motion. The scrub person controls the free end of the suture to prevent dragging it across the sterile field, and to keep the suture from entering the surgeon's hand along with the needleholder.



- The surgeon begins closure with the swaged suture.

FIGURE 14

### PLACEMENT OF THE NEEDLE IN TISSUE



- The needle is passed into the tissue. The surgeon releases the needle from the holder and reclaims the holder onto the body of the needle near the point end to pull the needle and strand through tissue. The needle is released or cut from the suture strand. The surgeon leaves the needle clamped in the same position and returns it to the scrub person. The scrub person immediately passes another prepared suture to the surgeon, one-for-one.



fibrous than anticipated and require the use of a heavier gauge needle. Conversely, a smaller needle may be required when tissue is more friable than usual.

- In a deep, confined area, ideal positioning of the needle may not be possible. Under these circumstances, proceed with caution. A heavier gauge needle or a different curvature may help and a second needleholder should be used to locate a needle in a confined body cavity.
- If a glove is punctured by a needle, the needle must be discarded immediately and the glove must be changed for the safety of the patient, as well as the surgical team. Appropriate

serological testing of the patient should be undertaken for transmissible agents such as hepatitis B and C and HIV.

### NEEDLE HANDLING TIPS

Needles should be protected from bacterial contamination and damage during handling by adhering to the following guidelines:

- Open needle packets and prepare sutures carefully, protecting needle sharpness.
- Make sure the needle is free of corrosion.
- If using eyed needles, make sure they do not have rough or sharp

- edges inside the eye to fray or break suture strands. Also check the eyes for burrs or bluntness to ensure easy penetration and passage through tissue.
4. If a needle is defective, discard it.
  5. Pass needles on an exchange basis; one is passed to the surgeon for one returned.
  6. Employ the nontransfer technique to avoid inadvertent needlesticks: the surgeon places the needle and needleholder down in a neutral area of the sterile field; the scrub person then picks up the needleholder.
  7. Secure each needle as soon as it is used. Do not allow needles to lie loose on the sterile field or Mayo stand. Keep them away from sponges and tapes so they will not inadvertently be dragged into the wound.
  8. If a needle breaks, all pieces must be accounted for.
  9. Count all needles before and after use according to hospital procedure. Retain the packets containing descriptive information on quantity and needle type for swaged needles to help determine if all are accounted for.

Follow these steps for safe needle handling:

1. Use sterile adhesive pads with or without magnets or disposable magnetic pads to facilitate counting and safe disposal.
2. Swaged needles can be inserted through or into their original packet after use. An empty packet indicates a missing needle. If using an E-PACK\* procedure kit, compare the count of needles

used to the number preprinted on the kit label.

3. Return eyed needles to the needle rack. If eyed needles are to be reused, they must be cleaned and reprocessed at the end of the operation.
4. Do not collect used needles in a medicine cup or other container since they must then be handled individually to count them. This can potentially contaminate gloves and increase the risk of an accidental puncture.
5. Discard used needles in a "sharps" container.

## IN THE NEXT SECTION

In the section that follows, the dual role that suture and needle packaging plays will be covered. Packaging does much more than keep the needle and suture sterile. Package design can help or seriously hinder the efficiency of the surgical procedure.



**PACKAGING**



## AN INTEGRAL PART OF THE PRODUCT

The purpose of a package is to protect its contents and provide convenience to the user.

ETHICON\* wound closure packaging is an integral part of each product. Over the past half a century, packaging has evolved from glass tubes packed in jars, to multi-layered foil and paper packages, to new materials that reflect concern for both the environment and the individuals who must maintain operative sterility and efficiency. Packaging has kept pace with the technological developments of wound closure products themselves. Several factors have influenced these developments:

- ◆ Increasing product diversity
- ◆ Technological advances in packaging materials
- ◆ Stringent regulatory requirements

To prevent infection in an operative wound, all instruments and supplies that come in contact with the wound must be sterile (free of living microorganisms and spores) including sutures, needles, ligating clips, stapling instruments, adhesive tapes and topical skin adhesives. High standards and criteria are set for all components in the packaging of sterile products:

1. Protect and preserve product stability and sterility from potential deterioration from outside forces such as oxygen, moisture, light, temperature, dust, and vermin.
2. Prevent product damage or microbial contamination in transit and storage.
3. Provide identifiable product

information.

4. Permit convenient, safe, and sterile transfer of the product from the package to the sterile field.
5. Meet the functional needs of all members of the surgical team.

## RELAY\* SUTURE DELIVERY SYSTEM

Most suture materials are packaged and sterilized by the manufacturer. They arrive ready for use in boxes which can be stored until needed. The RELAY\* suture delivery system, developed by ETHICON with human, clinical, and environmental factors in mind, stores and delivers sutures in a time-efficient manner and reduces unnecessary handling to access sutures. The system also provides control over suture storage, usage, inventory rotation, needle counting, and cost contain-

ment. The RELAY suture system consists of three basic, interrelated components: modular suture storage racks, dispenser boxes, and primary packets.

## MODULAR STORAGE RACKS

The modular storage racks are designed for maximum convenience and versatility to meet the individual needs of a particular specialty, nurse, surgeon, or department. Modules can be easily assembled to accommodate both vertical and horizontal suture dispenser boxes. Any number of modules can be fastened together to meet both small and large storage needs. Once assembled, the racks may be used on shelves, mounted on walls, placed on mobile carts, or connected to IV poles. Racks can also be fitted with a rotating base for more convenient access, as well as with a handle for easy carrying. Each module has a built-in



Full-vertical boxes

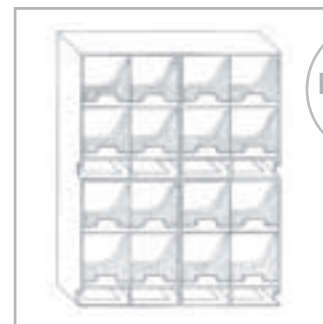

Half-vertical boxes

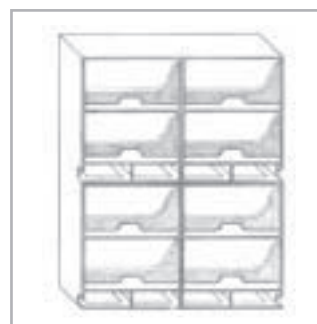

Horizontal boxes



Combination of boxes

FIGURE 1

ETHICON  
MODULAR  
STORAGE  
RACKS

inventory control area to facilitate restocking. This feature enables unused suture packets to be systematically fed back into the proper rotational flow without mixing lots within the boxes. Sutures may be grouped within the modular system by material type or size, or by use (i.e., general closure, gastrointestinal surgery, plastic surgery, etc.).

### DISPENSER BOXES

Gravity-fed dispenser boxes dispense suture packets from the opening at the bottom of the box. The opening can accommodate the removal of several suture packets at one time.

All ETHICON\* dispenser boxes are made of recyclable paper and printed with either water or soy-based inks. Each box provides clear product identification through streamlined graphics, product color coding, bold label copy, and descriptive symbols. The information required for quick reference and easy selection of suture materials is highlighted in a logical sequence. The three most important criteria necessary for proper identification and suture selection are:

1. Suture size
2. Suture material
3. Type and size of needle

Other important product information found on all suture boxes includes:

1. Surgical application
2. Product code number
3. Suture length and color
4. Metric diameter equivalent of suture size and length
5. Shape and quantity of needles (single- or double-armed, shown

- by silhouette)
6. Needle point geometry
7. Lot number
8. Expiration date

A package insert with detailed information about the suture material is inserted in every dispenser box. Users should be familiar with this information as it contains FDA-approved indications, contraindications, and all appropriate warnings and precautionary statements for each product.

Dispenser boxes should be restocked when the last few suture packets appear in the box opening, *before* the box is completely empty. The unused packets from the previous box should be used before a new dispenser box is opened. This will help to avoid mixing lot numbers and ensure proper stock rotation. ETHICON advocates rotation of the entire dispenser box. In addition to ensuring the use of the oldest suture materials first, this helps to maintain a fresh stock of dispenser boxes.

Most dispenser boxes contain three dozen suture packets. Others may contain one or two-dozen packets. The product code number suffix and a statement on the box indicate the quantity of suture packets in the box (product code suffix G = 1 dozen, D = 1 dozen, T = 2 dozen, H = 3 dozen). The dispenser boxes are held securely for easy dispensing by firmly pushing the box into a "lock" in the back of the rack module.

### PRIMARY PACKETS

Individual sutures and multiple suture strands are supplied sterile within a primary packet. The exterior surfaces of the overwrap are

not sterile. ETHICON primary packaging is designed to permit fast and easy opening in one peelable motion. The single layer overwrap of primary packaging is made of either foil *or* coated Tyvek® on one side heat-sealed to polyethylene film on the other. Absorbable sutures are always encased in foil to provide a safe and durable moisture barrier and to withstand sterilization in the manufacturing process. Most nonabsorbable sutures are encased in coated Tyvek® overwraps.

In a continuous effort to be more environmentally conscious, ETHICON has chosen materials in the manufacture of primary packets which generate minimal negative impact to the environment upon incineration or disposal. Furthermore, wherever possible, the number of primary packaging layers has been reduced by as much as 50 percent, thus reducing the volume of environmental waste per OR procedure.

Each primary packet provides critical product information and the same color-coding as its dispenser box. The packet also identifies the product code number, material, size, needle type, and the number of needles per packet to simplify needle counts.

Primary packets of suture material may contain sutures in one of five styles:

1. Standard lengths of non-needled material: 54 inches (135cm) of absorbable or 60 inches (150cm) of nonabsorbable suture, which may be cut in half, third, or quarter lengths for ligating or threading.
2. SUTUPAK\* pre-cut sterile suture

ABSORBABLE SUTURE	LAYERS
Surgical Gut Suture	Tyvek® overwrap, foil primary package containing one-step RELAY® suture delivery system tray
Coated VICRYL* <i>RAPIDE</i> (polyglactin 910) suture	Tyvek® overwrap, foil primary package, paper folder
MONOCRYL* (poliglecaprone 25) suture	Peelable foil overwrap, one-step RELAY tray
Coated VICRYL* <i>Plus</i> (polyglactin 910) suture	Peelable foil overwrap, one-step RELAY tray
Coated VICRYL* (polyglactin 910) suture	Peelable foil overwrap, one-step RELAY tray
PDS* II (polydioxanone) suture	Peelable foil overwrap, one-step RELAY tray
NONABSORBABLE SUTURE	LAYERS
PERMA-HAND* Silk Suture	Tyvek® overwrap, one-step RELAY tray
Stainless Steel Suture	Tyvek® overwrap, paper folder
ETHILON* nylon suture	Peelable foil overwrap, one-step RELAY tray
NUROLON* nylon suture	Tyvek® overwrap, one-step RELAY tray
MERSILENE* polyester fiber suture	Tyvek® overwrap, one-step RELAY tray
ETHIBOND* <i>EXCEL</i> polyester fiber suture	Tyvek® overwrap, one-step RELAY tray
PROLENE* polypropylene suture	Tyvek® overwrap, one-step RELAY tray
PRONOVA* poly (hexafluoropropylene-VDF) suture	Tyvek® overwrap, one-step RELAY tray

Tyvek® is a registered trademark of E.I. du Pont de Nemours and Company

TABLE  
1

**MOST  
COMMON  
ETHICON  
SUTURE  
PACKAGING**

is nonneeded material for ligating or threading. These lengths may be supplied in a multistrand labyrinth packet or in a folder packet, both of which are designed to deliver one strand at a time. SUTUPAK sutures may be removed from the packet and placed in the suture book.

- One single strand of material with single- or double-armed swaged needle(s). Needles for one-step RELAY suture packets, micro-surgery, and some ophthalmic needles are secured in a "needle park." The needle park is designed to provide a standard location for, and easy access to, the needle. All other needles are protected within an inner folder or other specific channel within a paper folder.

Most single strand needled sutures are sealed in convenient one-step RELAY delivery packages. One-step RELAY packages allow the needle to be armed in the needleholder from any angle without touching the needle. This increases the safety of handling needles intraoperatively. If it is preferred to locate the needle by hand, this can be accomplished with the one-step RELAY package by pushing up the flap behind the needle park, thereby elevating the needle so it can be grasped by hand.

- Multiple suture strands, either swaged to a single needle or double-armed. This type is appropriate for procedures requiring numerous interrupted sutures of the same type. It saves valuable operative time by enabling the surgeon to use one

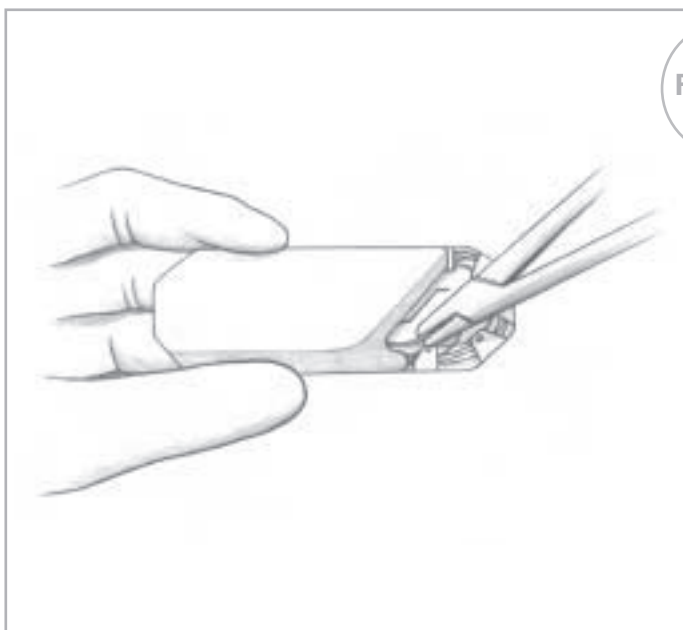

FIGURE  
2

**METHOD FOR  
PREPARING  
ONE-STEP  
RELAY  
PACKAGE  
SUTURES**

**Arm the needle directly from the one-step RELAY tray and deliver the single suture to the surgeon.**



suture while the next is being armed—without delay of opening packets or threading needles.

Multistrand packets are labeled with the symbol MS/ that denotes multiple strands/number of strands of surgical needles per packet. Multistrand packets may contain 3 to 10 swaged sutures. The inner folder for these products is white.

All packets containing CONTROL RELEASE\* needle sutures have multiple strands (8, 5, 4, 3, or 1) and are designated CR/8, CR/5, CR/4, CR/3, or CR/1. CONTROL RELEASE sutures may be available in foil or Tyvek® overwrap packets for single strand delivery. The single strand delivery *folder* is used for some coated VICRYL\* (polyglactin 910) sutures, MONOCRYL\* (poliglecaprone 25) sutures, PDS\* II (polydioxanone) sutures, ETHIBOND\* EXCEL polyester sutures, NUROLON\* nylon sutures, MERSILENE\* polyester sutures, and PERMA-HAND\* silk sutures. The suture material straightens as it is delivered from the folder. Each suture may be delivered to the surgeon individually from the opening packet or removed from the folder and placed in the suture book. The inner folder for these products is either red with a black C/R symbol or white with red lettering. The safety organizer tray is used for coated VICRYL sutures, MONOCRYL sutures, PDS II sutures, ETHIBOND EXCEL sutures, PERMA-HAND silk sutures, NUROLON nylon

sutures, MERSILENE sutures, and surgical gut sutures. The safety organizer tray allows for single strand arming and dispensing. The needles are situated in individually numbered needle parks and may be armed and dispensed with little or no hand-to-needle contact.

5. Ligating material used as either single strand (free or freehand) ties, or as continuous ties unwound from a reel or other device. The length of single strand ties is determined by the depth of the wound. In subcutaneous tissue, quarter lengths (approximately 14 inches) are usually long enough for ligating. Single strand ligating material is available in pre-cut lengths of 18, 24, and 30 inch strands.

Many surgeons prefer continuous ties. Some prefer LIGAPAK\* ligature, which is supplied on disc like plastic radiopaque dispensing reels that are color coded by material. The size of the ligature material is indicated by the number of holes visible on the side of the reel (e.g., 3 holes= 3-0 suture). The reel is held in the palm of the hand as blood vessels are ligated. Other surgeons may prefer the ligating material rewound onto a rubber reel, gauze sponge, metal bobbin, or other device.

The number of packets of ligating material required to tie off subcutaneous vessels (bleeders) will vary with patient size and age, the amount of bleeding, the type of operation, the length of the incision, and the surgical technique. An

abdominal incision 8 to 12 inches long might require one to three packets to ligate the subcutaneous blood vessels.

All suture material is packaged dry with the exception of surgical gut and pliability ETHILON sutures. Natural absorbable suture materials are packaged with a small amount of sterile fluid, usually alcohol with water, to maintain pliability. They should therefore be opened over a basin to prevent any solution from spilling onto the sterile field.

All needles should be counted after packets of swaged sutures are opened, according to established hospital procedure. The packets should be retained to facilitate verification of the final needle count after the surgical procedure.

### E-PACK\* PROCEDURE KIT

The E-PACK procedure kit contains numerous sutures and other products for a specific procedure, surgeon, or surgical specialty. The packaging concept saves valuable time in the OR by eliminating the need to open and coordinate multiple individual suture packages. The E-PACK procedure kit is also an effective means of reducing inventory levels of individual product codes, and providing a record for determining the suture costs associated with a given surgical procedure. The suture packages are secured

in an organizer sleeve to facilitate sterile transfer to the sterile field. The procedure kit label provides all the pertinent information regarding the number and types of needles, as well as sizes and types of suture. Suture quantities are listed on the label, making it easy to quickly determine how many needles have been used and thus simplifying needle accountability at the end of the procedure. The organizer sleeve is delivered in a Tyvek® pouch.

## EXPIRATION DATE

The expiration date of a product is determined by product stability studies. The Food and Drug Administration (FDA) requires that all synthetic absorbable suture products have an expiration date stamped on each dispenser box and primary packet to indicate the known shelf life of the material, provided the physical integrity of the package is maintained. Tests conducted by ETHICON\* show conclusively that synthetic absorbable suture products such as Coated VICRYL\* suture and PDS\* II suture continue to meet all product requirements even at five years of storage.

In addition, all ETHICON nonabsorbable suture products contain a five-year expiry dating on each dispenser box and primary packet. This expiry dating is necessary to comply with various international regulatory guidelines and is an aid in inventory management.

The RELAY suture delivery system is designed as a "first-in, first-out" inventory control system. Dispenser boxes are rotated, permitting the oldest sutures to be used first. The expiration date stamped on the outside of each box and every packet clearly indicates the month and year of product expiration.

## SUTURE STERILIZATION

Sutures sterilized by ETHICON are either irradiated with cobalt 60 or exposed to ethylene oxide gas. Both processes alter proteins, enzymes, and other cellular components to the extent that microorganisms are unable to survive or cause infection. Irradiation and ethylene oxide gas are considered cold sterilization processes because radiation sterilizes at room temperature and ethylene oxide gas sterilizes at much lower temperatures than other sterilization methods such as dry heat or steam under pressure.

Irradiation sterilization exposes products to ionizing radiation—either beta rays produced by high energy electron accelerators or gamma rays from radioisotopes—until absorbed in appropriate sterilizing dose. ETHICON was a pioneer in both beta and gamma irradiation and routinely sterilizes products with cobalt 60 which emits gamma rays. Cobalt 60 irradiation is the simplest of all sterilization processes.

Some suture materials cannot withstand the effects of irradiation sterilization, becoming unusable. Instead, they are gas sterilized.

Gas sterilization uses ethylene oxide gas. As an environmental measure, ETHICON replaced chlorofluorocarbons (CFCs) with more environmentally friendly compounds in all gas sterilization processes. The combination of ethylene oxide gas concentration, temperature, humidity, and exposure time must be carefully controlled to ensure reliable sterilization.

**WARNING:** Surgical sutures are labeled as disposable, single-use medical devices. Suture products manufactured by ETHICON are provided in easy-to-use packages designed to maintain the stability and sterility of the suture and needle materials. The component layers of packaging materials do not permit exposure to high temperatures or extremes of pressure without affecting package and product integrity. For this reason, all sterile products manufactured by ETHICON are clearly labeled, "DO NOT RESTERILIZE."

Manufacturers cannot be held responsible for the quality, effectiveness, or integrity of suture materials resterilized in the hospital, office, or by outside vendors. Therefore, if customers utilize the services of a sterilization reprocessor for suture, ETHICON will disclaim any responsibility for sterilization and/or other product failures resulting from the resterilization process. The practice of resterilization is not recommended, except for ETHI-PACK\* pre-cut steel sutures and spools or cardreels of nonabsorbable materials supplied nonsterile.

## ANTICIPATING SUTURE NEEDS

Today's healthcare environment dictates that hospitals continue to maintain quality standards while lowering costs to remain financially viable. Through total quality management initiatives, many hospitals have identified material use as an opportunity to lower cost. To increase the efficiency of suture utilization during a surgical procedure, it is important to determine and anticipate the surgeon's needs more precisely. For this reason, a file system of preference cards for each surgeon on staff is usually maintained in the operating suite. The cards contain such information as the surgeon's "suture routine," suture materials, sizes, needles, and/or product code numbers customarily used in specific procedures.

Becoming more aware of each surgeon's routine through good communication and regularly updated preference cards can help reduce preparation time, minimize waste, and assure cost effectiveness. Prior to dispensing suture packets, the circulating nurse should have a brief discussion with the surgeon to ascertain whether a change in suture routine is anticipated due to a specific patient's needs.

While it is difficult to say precisely how many suture packets are *enough*, three major factors should be considered in deciding how many packets to open:

1. Fewer packets will be needed if products with multiple strands of suture material are used.

2. Opening sufficient suture packets to prevent prolonging operative time and causing surgeon inconvenience.
3. Leftover suture on the surgical field must be discarded. Therefore, opening too many suture packets should be avoided to reduce waste and to lower cost.

Although it is important to be prepared to answer requests at a moment's notice, it is not necessary to overload the table with sutures. The introduction of single-layer peelable packaging, such as one-step RELAY\* packaging, helps encourage less handling to access the suture, enhancing quick delivery of suture materials to the surgeon in the sterile field. Unexpected suture needs can also be obtained rapidly from the storage racks.

### STERILE TRANSFER OF SUTURE PACKETS

At some point, suture packets must cross the sterile barrier—the invisible line of demarcation between the sterile and the nonsterile. In all settings (e.g., operating room, delivery room, emergency department, or physician's office), the individual who removes the nonsterile overwrap must remember these three points about sterile transfer:

1. Outer surfaces of the overwrap are not sterile and may be handled with nonsterile hands.
2. The sterile inner packet or tray must be transferred to the sterile field without being touched or contacting any nonsterile object or surface.

3. Nonsterile hands over the sterile field violate aseptic technique.

There are two methods commonly used for achieving sterile transfer of suture packets: handing-off the sterile inner one-step RELAY tray directly to the scrub person or "flipping" the inner contents of the primary packet onto the sterile field. Regardless of the aseptic technique performed, all items introduced onto the sterile field should be opened, dispensed, and transferred by methods that maintain product sterility and integrity. AORN Guidelines recommend the "hand-off" method, since items tossed or flipped have a greater potential to roll off the edge of the sterile field, causing contamination or other items to be displaced.

### METHOD I: STERILE TRANSFER TO THE SCRUB PERSON

Grasp the two flaps of the peelable overwrap between the knuckles of the thumbs and forefingers. With a rolling-outward motion, peel the flaps apart to approximately one-third of the way down the sealed edges. Keeping pressure between the knuckles for control, offer the sterile inner packet or tray to the scrub person, who takes it with a gloved hand or sterile instrument. Care must be taken to avoid contact with the nonsterile overwrap as the packet or tray is withdrawn.

This method must be used to remove paper folder packets of surgical steel and PROLENE\* sutures from long straight overwraps, and to remove the organizer sleeves from E-PACK\* procedure kits. It should also be used for transfer of flexible,

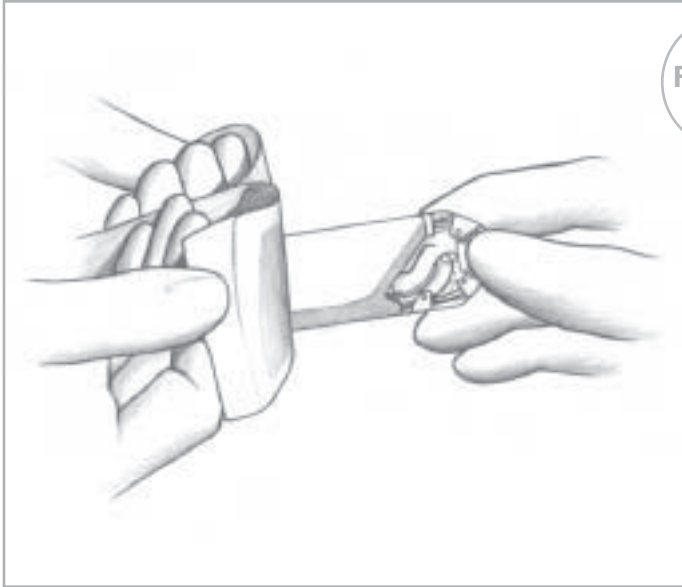

FIGURE 3

### STERILE TRANSFER TO THE SCRUB PERSON

lightweight, transparent packets containing microsurgery and ophthalmic products.

#### METHOD II: STERILE TRANSFER TO THE STERILE FIELD

"Flipping" is a rapid and efficient method of ejecting sterile product from its overwrap onto the sterile field without contacting the unsterile outer packet or reaching over the field. However, skill must be acquired to ensure its effective use. The circulating nurse must stand near enough to the sterile table to project the suture packet or tray onto it, but not too close as to risk contaminating the table by touching it or extending nonsterile hands over it. To accomplish this, grasp the flaps of the overwrap as described in Method I and peel the flaps apart with the same rolling-outward motion. The sterile packet or tray is projected onto the sterile table as the overwrap is completely peeled apart.

**NOTE:** DO NOT attempt to project the inner folder of long straight packets onto the sterile table.

Instead, present them to the scrub person as outlined in Method I.

#### SUTURE PREPARATION IN THE STERILE FIELD

Suture preparation may be more confusing than virtually any other aspect of case preparation.

Familiarity and understanding of the sequence in which tissue layers are handled by the surgeon will help to eliminate this confusion. (*See the Suturing Section, Chapter 2.*)

Once the suture packets are opened and prepared according to the surgeon's preference card, sutures can be organized in the sequence in which the surgeon will use them. Ligatures (ties) are often used first in subcutaneous tissue shortly after the incision is made, unless ligating clips or an electrosurgical cautery device is used to coagulate severed blood vessels.

After the ligating materials have been prepared, the suturing (sewing) materials can be prepared in the same manner. Preparing large amounts of suture material in

#### PREPARATION OF STANDARD LENGTH LIGATURE STRANDS

FIGURE 4



1. Prepare cut lengths of ligature material, coil around fingers of left hand, grasp free ends with right hand, and unwind to full length.

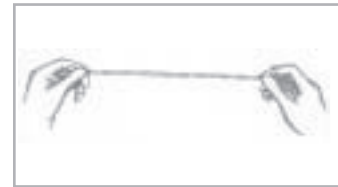

2. Maintain loop in left hand and two free ends in right hand. Gently pull the strand to straighten.

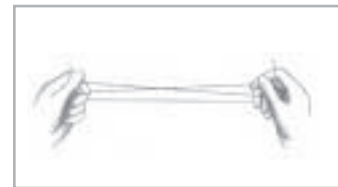

3. To make  $\frac{1}{3}$  lengths: Pass one free end of strand from right to left hand. Simultaneously catch a loop around third finger of right hand. Make strands equal in thirds and cut the loops with scissors.



4. To make  $\frac{1}{4}$  lengths: Pass both free ends from right to left hand. Simultaneously catch a double loop around third finger of right hand. Cut the loops.



5. Place packets or strands in suture book (folded towel)—or under Mayo tray—with ends extended far enough to permit rapid extraction.



**PREPARATION OF CONTINUOUS TIES ON A LIGAPAK DISPENSING REEL**

**FIGURE 5**

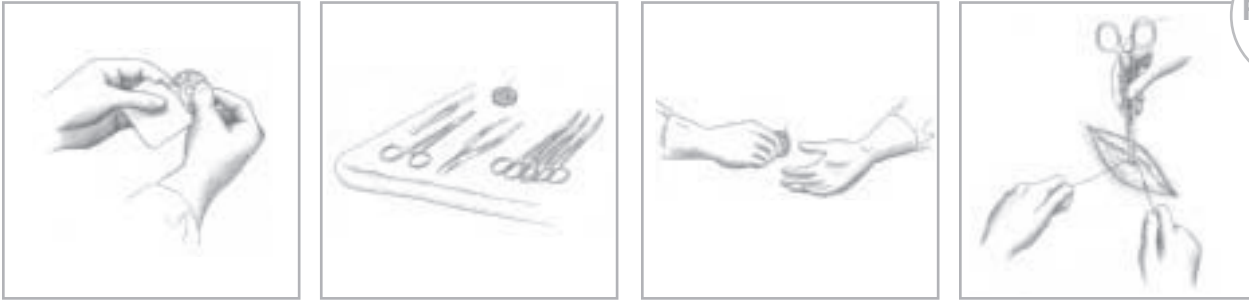

1. Open the packet containing the appropriate material on a reel. Transfer the inner contents of the primary packet to the sterile field using aseptic technique.
2. Extend the strand end slightly for easy grasping. Place reel conveniently on the Mayo tray.
3. Hand reel to surgeon as needed, being certain that the end of the ligating material is free to grasp.
4. Surgeon holds reel in palm, feeds strand between fingers, and places around tip of hemostat.

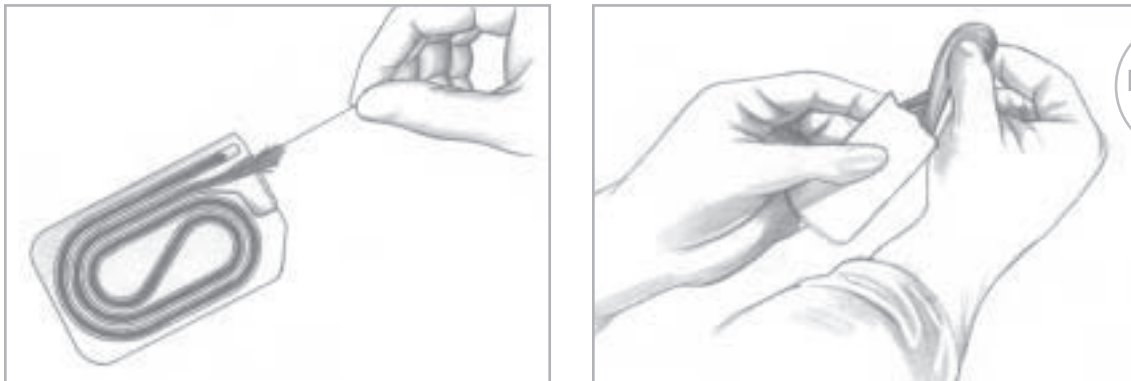

**FIGURE 6**

**PREPARATION OF PRE-CUT SUTURES FOR TIES OR LIGATURE SUTURES**

1. Remove one pre-cut length from nonabsorbable suture at a time from the labyrinth packet as it is needed by the surgeon.
2. Extract pre-cut strands of SUTUPAK\* sterile absorbable or nonabsorbable suture. Straighten surgical gut with a gentle pull. Place strands in the suture book or under Mayo tray.

advance should be avoided. For example, if the surgeon opens the peritoneum (the lining of the abdominal cavity) and discovers disease or a condition that alters plans for the surgical procedure and anticipated use of sutures, opened packets would be wasted. At closure following abdominal surgery, remembering the letters PFS (*peritoneum, fascia, skin*) will be helpful for organizing sutures.

By watching the progress of the procedure closely, listening to comments between the surgeon and assistants, and evaluating the situation; suture needs can be anticipated. Free moments can

be used to prepare sufficient suture material to stay one step ahead of the surgeon. The goal should be to have no unused strands at the end of the procedure.

Ligature material which remains toward the end of the procedure may be the same material and size specified by the surgeon for sutures in the subcutaneous layer of wound closure. In this case, the remaining ligating material should be used rather than opening an additional suture packet.

If the surgeon requires "only one more suture," and strands of suitable material remain which

are shorter than those prepared originally, do not be reluctant to ask the surgeon if one of the strands will serve the purpose before opening a new packet. Most surgeons are cooperative in efforts to conserve valuable supplies.

**SUTURE HANDLING TECHNIQUE**

During the first postoperative week, the patient's wound has little or no strength. The sutures or mechanical devices must bear the responsibility of holding the tissues together during this period. They can only perform this function reliably if the quality and integrity of the wound

\* Trademark

closure materials are preserved during handling and preparation prior to use. It is therefore essential for everyone who will handle the suture materials to understand proper procedure to preserve suture tensile strength.

In general, avoid crushing or crimping sutures with surgical instruments such as needleholders and forceps, except as necessary to grasp the free end of a suture during an instrument tie. There are also specific procedures to follow to preserve suture tensile strength which depend upon whether the material is absorbable or nonabsorbable. The following summarizes the most important points for each member of the surgical team to remember and observe in handling suture materials and surgical needles.

#### FOR THE CIRCULATING NURSE

1. Consult the surgeon's preference card for suture routine.
2. Check the label on the dispenser box for type and size of suture material and needle(s). Note the number of strands per packet. Fewer packets will be needed if multistrand or CONTROL RELEASE\* sutures are used.
3. Estimate suture requirements accurately and dispense only the type and number of sutures required for the procedure.
4. Read the label on the primary packet or overwrap before using to avoid opening the wrong packet.
5. Use aseptic technique when peeling the overwrap. Transfer the inner contents of the primary packet to the sterile field by offering it to the scrub person or

- by projecting (flipping) it onto the sterile table, avoiding contamination.
6. To open long straight packets, peel overwrap down 6 to 8 inches and present to the scrub person. Do not attempt to project the inner folder of long straight packets onto the sterile table.
7. Maintain an adequate supply of the most frequently used sutures readily accessible.
8. Rotate stock using the "first-in, first-out" rule to avoid expiration of dated products and keep inventories current.
9. Suture packets identify the number of needles per packet to simplify needle counts. Retain this information during the procedure and/or until final needle counts are completed.
10. Count needles with the scrub person, per hospital procedure.



1. With a rolling-outward motion, peel the flaps apart to approximately one-third the way down the sealed edges. Keeping pressure between the knuckles for control, offer the sterile inner RELAY tray to the scrub person.



2. Clamp the needleholder approximately one-third to one-half of the distance from the swage area to the needle point. Do not clamp the swaged area. Gently pull the suture to the right in a straight line.

FIGURE 7

#### ETHICON MODULAR STORAGE RACKS



3. Additional suture straightening should be minimal. If the strand must be straightened, hold the armed needleholder and gently pull the strand making certain not to disarm the needle from the suture.

#### FOR THE SCRUB PERSON

1. If appropriate, remove the inner one-step RELAY\* tray or folder containing suture materials from the primary packet being offered from the circulating nurse.
2. Hold the one-step RELAY tray or folder in gloved hand and arm the needle using the "no-touch" technique. Gently dispense the suture.
3. Leave pre-cut suture lengths in labyrinth packet on the Mayo tray. Strands can then be removed one at a time as needed.
4. Surgical gut and collagen sutures for ophthalmic use must first be rinsed briefly in tepid water to avoid irritating sensitive tissues.

If the surgeon prefers to use sutures wet, dip only momentarily. Do not soak. Silk sutures should be used dry.

5. Do not pull or stretch surgical gut or collagen. Excessive handling with rubber gloves can weaken and fray these sutures.
6. Count needles with the circulating nurse, per hospital procedure.
7. Hold single strands taut for surgeon to grasp and use as a freehand tie.
8. Do not pull on needles to straighten as this may cause premature separation of CONTROL RELEASE needle suture.
9. Always protect the needle to prevent dulling points and cutting edges. Clamp the needleholder forward of the swaged area, approximately one-third to one-half the distance from the swage to the point.
10. Microsurgery sutures and needles are so fine that they may be difficult to see and handle. They are packaged with the needles parked in foam to protect delicate points and edges. The needles may be armed directly from the foam needle park. If the microsurgeon prefers to arm the needle, the removable orange colored tab may be used to transport the needle into the microscopic field.
11. Handle all sutures and needles as little as possible. Sutures should be handled without using instruments unless absolutely necessary. Clamping instruments

on strands can crush, cut, and weaken them.

12. Cut sutures only with suture scissors. Cut surgical steel with wire scissors.
13. When requesting additional suture material from the circulating nurse, estimate usage as accurately as possible to avoid waste.

#### FOR THE SURGEON

1. Avoid damage to the suture strand when handling. This is particularly critical when handling fine sizes of monofilament material. Touch strands only with gloved hand or closed blunt instrument. Do not crush or crimp sutures with instruments, such as needleholders or forceps, except when grasping the free end of the suture during an instrument tie.
2. Clamp a rubber shod hemostat onto the suture to anchor the free needle on a double-armed strand until the second needle is used. Never clamp the portion of suture that will be incorporated into the closure or the knot.
3. Use a closed needleholder or nerve hook to distribute tension along a continuous suture line. Be careful not to damage the suture.
4. Use knot tying techniques that are appropriate for the suture material being used.

1. Protect absorbable sutures from heat and moisture.
  - a. Store suture packets at room temperature. Avoid prolonged storage in hot areas such as near steam pipes or sterilizers.
  - b. Do not soak absorbable sutures. Also avoid prolonged placement of sutures in a moist suture book.
  - c. Surgical gut can be dipped momentarily in tepid (room temperature) water or saline to restore pliability if strands dry out before use. Surgical gut or collagen for use in ophthalmic surgery should be rinsed briefly in tepid water before use, as they are packed in a solution usually consisting of alcohol and water to maintain pliability.
  - d. Synthetic absorbable sutures must be kept dry. Use strands directly from packet when possible. Store sutures in a dry suture book if necessary.
2. Straighten strands with a gently, steady, even pull. Jerking and tugging can weaken sutures.
3. Do not "test" suture strength.
4. Do not resterilize.

TABLE  
2

**PRESERVATION  
OF TENSILE  
STRENGTH:  
ABSORBABLE  
SUTURES**

**SILK** – Store strands in a dry towel. Dry strands are stronger than wet strands. Wet silk loses up to 20% in strength. Handle carefully to avoid abrasion, kinking, nicking, or instrument damage. Do not resterilize.

**SURGICAL STAINLESS STEEL** – Handle carefully to avoid kinks and bends. Repeated bending can cause breakage. Stainless steel suture can be steam sterilized without any loss of tensile strength. However, **DO NOT** steam sterilize on spool or in contact with wood. Lignin is leached from wood subjected to high temperature and may cling to suture material. Handle carefully to avoid abrasion, kinking, nicking, or instrument damage.

**POLYESTER FIBER** – Unaffected by moisture. May be used wet or dry. Handle carefully to avoid abrasion, kinking, nicking, or instrument damage. Do not resterilize.

**NYLON** – Straighten kinks or bends by "caressing" strand between gloved fingers a few times. Handle carefully to avoid abrasion, kinking, nicking, or instrument damage.

**POLYPROPYLENE** – Unaffected by moisture. May be used wet or dry. Straighten strands with a gentle, steady, even pull. Handle with special care to avoid abrasion, kinking, nicking, or instrument damage. Do not resterilize.

TABLE  
3

**PRESERVATION  
OF TENSILE  
STRENGTH:  
NONABSORBABLE  
SUTURES**



# TOPICAL SKIN ADHESIVES



Low tension wounds (those where the skin edges lie close together without significant tension) can be closed by gluing the skin edges together with a skin adhesive. Butylcyanoacrylate adhesives have been available in Europe, Israel, and Canada for decades.<sup>1</sup> They have been used successfully for the closure of traumatic lacerations and surgical incisions. Application of butylcyanoacrylate was found to be more rapid and cost effective than suturing, but only recently has it been evaluated in well-designed clinical trials for wound closure.<sup>1</sup> The most significant advance in the field of topical skin adhesives has been the development of 2-octyl cyanoacrylate, marketed as DERMABOND\* Topical Skin Adhesive by ETHICON Products. This topical skin adhesive forms a transparent and flexible bond, unlike the opaque and brittle bond formed by butylcyanoacrylate adhesives. The flexibility of octyl cyanoacrylate allows it to be applied over nonuniform surfaces. This flexibility also combats the topical shear forces exerted on the adhesive, reducing the risk of premature sloughing and wound dehiscence. Additionally, octyl cyanoacrylate adhesive has been found to have three times the breaking strength of butylcyanoacrylate, so it can be used on longer incisions and lacerations.<sup>1</sup>

**DERMABOND\*  
TOPICAL SKIN ADHESIVE  
(2-OCTYL CYANOACRYLATE)**

is a sterile, liquid topical adhesive designed to hold closed, easily approximated skin edges of lacerations and surgical incisions.

It utilizes the moisture on the skin's surface to form a strong, flexible bond and can be used in many instances where sutures, staples or skin strips have been traditionally used. DERMABOND adhesive is ideally suited for wounds on the face, torso and limbs. It can be used in conjunction with, but not in place of, deep dermal sutures.

Approved by the FDA in 1998, DERMABOND adhesive has been used extensively by health professionals in the fields of trauma and other surgeries, emergency medicine, and pediatrics. Since its approval, DERMABOND adhesive has been proven effective in closing a variety of surgical incisions and wounds. Unlike sutures, the adhesive does not produce suture or "track" marks along the healed incision and a patient can shower right away without fear of compromising the incision.

**HIGH VISCOSITY  
DERMABOND\*  
TOPICAL SKIN ADHESIVE  
(2-OCTYL CYANOACRYLATE)**

*High Viscosity* DERMABOND adhesive is 6 times thicker<sup>2</sup> for better control, especially where runoff is most likely to occur, such as around the eyes and nose.

Dome-, Precision-Tip and NEW DERMABOND ProPen adhesive applicators allow for fine-line delivery of adhesive<sup>2</sup> – ideal for delicate skin closures on the face and near the eyes.

New DERMABOND ProPen adhesive and DERMABOND ProPen XL adhesive deliver the high viscosity formulation with greater ease of use. DERMABOND

ProPen XL adhesive delivers twice as much adhesive for use on longer incisions and lacerations.

**STRENGTH AND SECURITY**

In less than three minutes, DERMABOND adhesive provides the strength of healed tissue at 7 days.<sup>2</sup> A strong, flexible 3-dimensional bond makes it suitable for use in closing easily approximated incisions of many types (example—deep, short, long).<sup>3</sup>

**SEALS OUT BACTERIA**

DERMABOND adhesive *is approved to protect wounds and incisions from common microbes that can lead to infection.* For trauma and post-surgical patients, infections are often the most common, and in some cases, the most serious complications. DERMABOND adhesive helps protect against the penetration of bacteria commonly associated with surgical site infections.<sup>2</sup> *In vitro* studies demonstrated that DERMABOND acts as a barrier against *Staphylococcus epidermidis*, *Staphylococcus aureus*, *Escherichia coli*, *Pseudomonas aeruginosa* and *Enterococcus faecium* as long as the adhesive film remains intact.<sup>2</sup>

**PROMOTES A MOIST,  
WOUND HEALING ENVIRONMENT**

DERMABOND adhesive creates a protective seal and is an occlusive dressing that helps the wound stay moist.<sup>2</sup> Maintaining a moist wound healing environment around the wound has been shown to speed the rate of epithelialization.<sup>4</sup> As the wound heals, DERMABOND adhesive will gradually slough off (generally between 5 to 10 days).<sup>2</sup>

### PROVIDES EXCELLENT COSMETIC RESULTS

In a prospective, randomized, controlled, unmasked study of 818 patients, DERMABOND adhesive provided cosmesis equivalent to that of sutures. At 3 months, it produced optimal cosmesis in 80% of patients, using the Modified Hollander Cosmesis Scale.<sup>2</sup>

### ADDITIONAL PHYSICIAN AND PATIENT BENEFITS

In most cases, DERMABOND adhesive allows for significantly faster closure than sutures.<sup>3,5,6</sup> DERMABOND adhesive application requires fewer surgical supplies, reduced equipment needs, and eliminates the need for suture removal.<sup>6,7</sup>

DERMABOND adhesive is also more convenient and comfortable for the patient because it often does not require anesthetic, is gentler to the skin than sutures or staples, and does not require suture removal. DERMABOND adhesive also reduces the risk of needle stick injury.

### INDICATIONS AND CONTRAINDICATIONS

DERMABOND adhesive is intended for topical application only to hold closed easily approximated skin edges of wounds from surgical incisions, including punctures from minimally invasive surgery, and simple, thoroughly cleansed, trauma-induced lacerations. DERMABOND adhesive may be used in conjunction with, but not in place of, deep dermal sutures. Topical skin adhesives are not appropriate for closing wounds that are subject to significant static or

dynamic tensions unless deep sutures, immobilization, or both are also used.

DERMABOND adhesive is contraindicated for use on any wounds with evidence of active infection or gangrene. It should also not be used on mucosal surfaces or across mucocutaneous junctions (e.g., lips, oral cavity), or on skin that is regularly exposed to body fluids or with dense hair (e.g., scalp). DERMABOND adhesive should not be used on patients with a known hypersensitivity to cyanoacrylate or formaldehyde.

### APPLICATION

Mastery of tissue adhesive use is generally quite rapid. Proper wound selection, evaluation and preparation before closure is important. Wounds must be thoroughly cleansed and debrided in accordance with standard practice before using adhesives. The wound edges must be tightly apposed so that the adhesive is not placed into the wound. Patient positioning is also important to reduce runoff of tissue adhesive. The patient should be positioned so that the wound surface is parallel to the floor, taking special care that any runoff does not flow in the direction of vital structures such as the eye.

### TECHNIQUE

1. Follow standard surgical practice for wound preparation and achieve hemostasis.
2. Approximate skin edges and use deep sutures to relieve tension if necessary.
3. Crack the DERMABOND adhesive vial in the upright position, invert, and apply pressure to saturate the tip. Release pressure, then reapply pressure to express adhesive. When using the *NEW* DERMABOND ProPen adhesive applicator, simply twist the collar to crack the vial and lightly press the button to saturate the tip and express the adhesive.
4. Apply 2 thin layers of adhesive, waiting approximately 30 seconds between layers (NOTE: 3 layers of adhesive are required when using original DERMABOND adhesive.)

### DIRECTIONS FOR USE

1. The application of high viscosity DERMABOND adhesive requires thorough wound cleansing. Follow standard surgical practice for wound preparation before application of high viscosity DERMABOND adhesive (i.e., anesthetize, irrigate, debride, obtain hemostasis and close deep layers).
2. Pat the wound dry with dry, sterile gauze to assure direct tissue contact for adherence of the high viscosity DERMABOND adhesive to the skin. Moisture accelerates high viscosity DERMABOND adhesive's polymerization and may affect wound closure results.
3. To prevent inadvertent flow of liquid high viscosity DERMABOND adhesive to unintended areas of the body, the wound should be held in a horizontal position and the high viscosity DERMABOND adhesive should be applied from above the wound.

## HOW TO CARE FOR A WOUND AFTER IT'S TREATED WITH DERMABOND\* TOPICAL SKIN ADHESIVE

TABLE  
1

DERMABOND Topical Skin Adhesive (2-octyl cyanoacrylate) is a sterile, liquid skin adhesive that holds wound edges together. The film will usually remain in place for 5 to 10 days, then naturally falls off the skin.

The following provides instructions for proper care of the wound while it is healing:

### CHECK WOUND APPEARANCE

Some swelling, redness and pain are common with all wounds and normally will go away as the wound heals. If swelling, redness, or pain increases or if the wound feels warm to the touch, instruct patients to contact a doctor. A doctor should also be contacted if the wound edges reopen or separate.

### REPLACE BANDAGES

If the wound is bandaged, the patient should be instructed to keep the bandage dry. The dressing should be replaced daily until the adhesive film has fallen off or if the bandage should become wet, unless otherwise instructed by the physician.

When changing the dressing, tape should not be placed directly over the DERMABOND adhesive film, because removing the tape later may also remove the film.



### AVOID TOPICAL MEDICATIONS

Instruct patients not to apply liquid or ointment medications or any other product to the wound while the DERMABOND adhesive film is in place. These may loosen the film before the wound is healed.

### KEEP WOUND DRY AND PROTECTED

Patients may occasionally and briefly wet the wound in the shower or bath. They should not soak or scrub the wound. They should not swim and should avoid periods of heavy perspiration until the DERMABOND adhesive has naturally fallen off. After showering or bathing, the patient should blot the wound dry with a soft towel. If a protective dressing is being used, a fresh, dry bandage should be applied, being sure to keep the tape off the DERMABOND adhesive film.

Additional instructions for patients include:

- Apply a clean, dry bandage over the wound if necessary to protect it.
- Protect the wound from injury until the skin has had sufficient time to heal.
- Do not scratch, rub or pick at the DERMABOND adhesive film. This may loosen the film before the wound is healed.
- Protect the wound from prolonged exposure to sunlight or tanning lamps while the film is in place.



4. High viscosity DERMABOND adhesive should be used immediately after crushing the glass ampule, since the liquid high viscosity DERMABOND adhesive will flow freely from the tip for only a few minutes. Remove the applicator from the blister pouch. Hold the applicator with the thumb and finger and away from the patient to prevent any unintentional placement of the liquid high viscosity DERMABOND adhesive into the wound or on the patient. While holding the applicator, and with the applicator tip pointed upward, apply pressure at the midpoint of the ampule to crush the inner glass ampule. Invert and gently squeeze the applicator just sufficiently to express the liquid high viscosity DERMABOND adhesive to moisten the applicator.
5. Approximate wound edges with gloved fingers or sterile forceps. Slowly apply the liquid high viscosity DERMABOND adhesive in multiple (at least 3) thin layers to the surface of the approximated wound edges using a gentle brushing motion. Wait approximately 30 seconds between applications or layers. Maintain manual approximation of the wound edges for approximately 60 seconds after the final layer.

**NOTE:** High viscosity DERMABOND adhesive polymerizes through an exothermic reaction. If the liquid high viscosity DERMABOND adhesive is applied so that large droplets are allowed to remain without being evenly spread, the patient may experience a sensation of heat or discomfort. The sensation may be higher on sensitive tissues. This can be minimized by applying high viscosity DERMABOND adhesive in multiple thin layers (at least 3).

**NOTE:** Excessive pressure of the applicator tip against the wound edges or surrounding skin can result in forcing the wound edges apart and allowing high viscosity DERMABOND adhesive into the wound. High viscosity DERMABOND adhesive withing the wound could delay wound healing and/or result in adverse cosmetic outcome.

**NOTE:** Full apposition strength is expected to be achieved about 2.5 minutes after the final layer is applied, although the top adhesive layer may remain tacky for up to approximately 5 minutes. Full polymerization is expected when the top high viscosity DERMABOND adhesive layer is no longer sticky.

6. Do not apply liquid or ointment medications onto wounds closed with high viscosity DERMABOND adhesive because these substances can weaken the polymerized film, leading to wound dehiscence.
7. Protective dry dressing such as gauze, may be applied only after high viscosity DERMABOND adhesive film is completely solid/polymerized: not tacky to the touch (approximately five minutes after application). Allow the top layer to fully polymerize before applying a bandage.  
If a dressing, bandage, adhesive backing or tape is applied before complete polymerization, the dressing can adhere to the film. The film can be disrupted from the skin when the dressing is removed, and wound dehiscence can occur.
8. Patients should be instructed to not pick at the polymerized film of high viscosity DERMABOND adhesive. Picking at the film can disrupt its adhesion to the skin and cause dehiscence of the wound. Picking at the film can be discouraged by an overlying dressing.
9. Apply a dry protective dressing for children or other patients who may not be able to follow instructions for proper wound care.
10. Patients treated with high viscosity DERMABOND adhesive should be provided the printed instruction sheet entitled, How to Care for Your Wound After It's Treated With high viscosity DERMABOND Topical Skin Adhesive. This instruction sheet should be reviewed with each patient or guardian to assure understanding of the proper care for the treatment site.
11. Patients should be instructed that until the polymerized film of high viscosity DERMABOND adhesive has sloughed naturally (usually in 5-10 days), there

should be only transient wetting of the treatment site. Patients may shower and bathe the site gently. The site should not be scrubbed, soaked, or exposed to prolonged wetness until after the film has sloughed naturally and the wound has healed closed. Patients should be instructed not to go swimming during this period.

12. If removal of high viscosity DERMABOND adhesive is necessary for any reason, carefully apply petroleum jelly or acetone to the high viscosity DERMABOND film to help loosen the bond. Peel off the film, do not pull the skin apart.

## REFERENCES

1. Singer, Adam J., *Lacerations and Acute Wounds, An Evidence-Based Guide*; F.A. Davis Company, 2003, p. 83-97.
2. Data on file, ETHICON, INC.
3. Quinn, G Wells, T Sutcliffe, et al. *A Randomized Trial Comparing Octyl Cyanoacrylate Tissue Adhesive and Sutures in the Management of Lacerations*. JAMA 1997;227(19):1527-1530.
4. Singer AJ, Hollander JE, Quinn JV. Evaluation and management of traumatic lacerations. N Engl J Med. 1997;337(16):1142-1148.
5. Bruns TB, Robinson BS, Smith RJ et al. *A new tissue adhesive for laceration repair in children*. J Pediatr. 1998;132:1067-1070.
6. Theodore N, et al. *The Economics of DERMABOND in Neurosurgical Wound Closure*. Phoenix, Ariz: Neuroscience Publications, Barrow Neurological Institute. March 2001:2-10.
7. Osmond MH, Klassen TP, Quinn JV. *Economic comparison of a tissue adhesive and suturing in the repair of pediatric facial lacerations*. J Pediatr. 1995; 126:892-895.

# OTHER SURGICAL PRODUCTS



## ADHESIVE TAPES

There are many surgical products available which may be used during wound closure and other operative procedures which involve suturing. Each of these products has specific indications for use. Adhesive tapes are used for approximating the edges of lacerations, skin closures, repair and/or support in selected operative procedures.

Adhesive tapes are associated with minimal tissue reactivity and yield the lowest rate of infection, but they tend to slough off in the presence of tension or moisture.<sup>1</sup> Advantages of adhesive tapes include rapid application, little or no patient discomfort, low cost, and no risk of needle-stick injuries. They are associated with minimal tissue reactivity and yield the lowest infection rates of any wound closure method. They may be left on for long periods without resulting in suture hatch marks.

Surgical tapes are not commonly recommended as the sole modality for primary wound closure due to the high probability of

dislodgement and dehiscence, the inability to use them in hair-bearing areas, and the need to keep them dry. Their use is typically reserved for linear lacerations under minimal tension. Furthermore, surgical tapes do not approximate deeper tissues and do not control bleeding.

### INDICATIONS AND USAGE

Skin closure tapes are an effective alternative to sutures or staples when tensile strength and resistance to infection are not critical factors. Skin closure tapes can also be used to complement suture or staple closures. Stress is applied uniformly to the collagen fibers, aiding in rapid fiber orientation and increased tensile strength.

### APPLICATION

Skin closure tapes may be applied to the skin over a subcuticular closure in lieu of skin sutures or used as a primary closure in conjunction with sutures in an alternating pattern. The tape is placed on one side of the wound at its midpoint, while grasping it with forceps in the dominant hand. The opposite

wound edge is then gently apposed by pushing with a finger of the nondominant hand. The wound edges *should not* be apposed by pulling on the free end of the tape. This can result in unequal distribution of skin tensions, causing erythema or even blistering of the skin. Additional strips are then placed perpendicular to the laceration on either side of the original tape, bisecting the remaining open wound with each strip until the space between tapes is no more than about 2 to 5 mm. Additional strips are then placed over the ends of the other strips, parallel to the laceration.

Skin closure tapes may also be used as a replacement for sutures or staples which are removed on the first to fourth postoperative day. Effective skin closure tapes provide good porosity in terms of air inflow to the wound and water vapor transmission escaping from the wound during the healing process.

### AFTER CARE AND REMOVAL

Adhesive tapes should be left in place as long as possible, at least as long as sutures would be left before removal. To prevent the tapes from prematurely coming loose, patients must be warned to keep them as dry as possible and not to cover them with ointments. Showering is permitted and during the first week many surgeons recommend that patients cover their wounds and tape with a nonadherent dressing.

ADVANTAGES	DISADVANTAGES
<ul style="list-style-type: none"> <li>• Rapid and simple closure</li> <li>• Least damage to host defenses</li> <li>• No risk of needle-stick injuries</li> <li>• Do not cause tissue ischemia or necrosis</li> </ul>	<ul style="list-style-type: none"> <li>• Relatively poor adherence</li> <li>• Easily removed by patient</li> <li>• Must be kept dry</li> <li>• Cannot be used over oily or hair-bearing areas</li> </ul>

TABLE 1

**ADVANTAGES AND DISADVANTAGES OF ADHESIVE TAPES FOR SKIN CLOSURE<sup>1</sup>**



1. Using sterile technique, remove card from sleeve and tear off tab.



2. Peel off tapes as needed in diagonal direction.



3. Apply tapes at  $1/8$ -inch intervals as needed to complete wound apposition. Make sure the skin surface is dry before applying each tape.



4. When healing is judged to be adequate, remove each tape by peeling off each half from the outside toward the wound margin. Then, gently lift the tape away from the wound surface.

FIGURE 1

### SKIN CLOSURE TAPES

#### SKIN CLOSURE TAPES

PROXI-STRIP\* skin closures are long, narrow, sterile strips of tape with an adhesive backing. They are used for approximating the edges of lacerations and for closing skin following many operative procedures.

PROXI-STRIP skin closures have a high degree of porosity to allow the wound to breathe, but have sufficient adhesive strength to negate the use of adjunct applications, such as tincture of benzoin. Their antistatic properties minimize the tendency of the tape strips to curl up.

#### POLYESTER FIBER STRIP

MERSILENE\* polyester fiber strip is comprised of a double thickness of MERSILENE polyester fiber that is 5mm wide. The strips are

available with and without needles and may be used instead of large-sized suture for ligation, repair, and/or support in selected operative procedures.

Incompetence of the cervix is a condition characterized by the habitual premature, spontaneous abortion of the fetus. A ligature is placed around the cervix in a collar-like fashion, drawn tight, and either sutured together or tied closed. A MERSILENE strip is then woven carefully with a swage blunt needle in and out of the mucosa. When placed properly, the flatness of the ligature will not cut or damage the wall of the cervix.

MERSILENE strip attached to a heavy reverse cutting needle provides a wide band of strong

material for orthopaedic procedures such as rotator cuff repair and support. The blunt needles used for the incompetent cervix ligation may also be used for this purpose.

#### UMBILICAL TAPE

Umbilical tape is a white woven cotton ligature,  $1/8$  or  $1/4$  inch (0.32 or 0.64cm) wide that is strong enough to tie off the umbilical cord of the newborn infant. While this was its original use, umbilical tape is also used in pediatric and cardiovascular procedures to suspend small structures and vessels during the operation, but is not left in place.

Umbilical tape easily absorbs blood when used in an area of gross bleeding. The  $1/8$ -inch (0.32cm) tape is available with a radiopaque thread woven into the length of the fabric to facilitate x-ray identification.

### SURGICAL STAPLES

The staple closure is mainly used for large wounds that are not on the face. Stapling is especially useful for closing scalp wounds. Staples are also used for linear lacerations of the torso and extremities, especially if they are relatively long.

Many surgeons routinely use skin staples for closure of standard abdominal, thorax and extremity incisions. Advantages of stapling include ease of use, rapidity, cost effectiveness, and minimal damage to host defenses.<sup>1</sup>



A variety of stapling devices is available for wound closure. With all devices, the staple creates an incomplete rectangle: the legs of the staple extend into the skin, and the cross-limb lies on the skin surface across the wound. Each device may differ in its handling characteristics, visual access, the angle at which the staples enter tissues, the ease of position and the pre-cocking mechanism. Optimal visibility as the staple is placed in the skin is important, as is the angle at which the staple enters the skin because insertion of the staple perpendicular to the surface of the skin results in deep penetration that increases the likelihood of tissue strangulation and permanent cross-hatching of the wound. The ability of the staple end to swivel allows the head to be adjusted for use in deep recesses. Finally, the presence of a pre-cocking mechanism allows the practitioner to maintain constant control while stapling the skin.<sup>1</sup>

Before inserting staples, it is important to line up the wound edges with the centerline indicator on the head of the stapler to make sure that the legs of the staple will enter the skin at equal distances on either side of the wound edge. Each edge is typically picked up with a forceps, everted and precisely lined up. The surgeon then places the staples to close the wound while the first assistant advances the forceps, everting the edges of the wound. This technique is continued until the entire wound is everted and closed with staples.<sup>2</sup>

#### INDICATIONS AND USAGE

Wound closure with staples is indicated for scalp lacerations that do not require extensive hemostasis and do not involve tears in the underlying frontooccipital aponeurosis (galea). They are also indicated for linear nonfacial lacerations caused by shear forces (e.g., sharp objects).

#### AFTERCARE AND REMOVAL

Skin staples should be removed at the same time that sutures would be removed, based on wound location and tension. For scalp wounds, staples should be removed on day 7 after insertion. For trunk and extremity wounds, staples should be removed between days 7 and 14. Wounds closed with staples may be covered with a topical antibiotic cream or ointment. Patients may bathe or shower the next day, but should avoid prolonged exposure to moisture. When used on the scalp, patients should be very careful about combing or brushing their hair. A specially designed, single-handed, disposable staple remover should be used to remove the staples by a health care provider.

#### PROXIMATE\* Skin Staplers

PROXIMATE Skin Staplers place single staples to close surgical incisions. Staples are made of lubricant-coated stainless steel;

#### PROXIMATE\* SKIN STAPLERS

TABLE 2

PROXIMATE* RH Skin Staplers (Rotating Head Skin Staplers)		PROXIMATE* PX Skin Staplers		PROXIMATE* PLUS MD Skin Staplers (Multi-Directional Skin Staplers)	
Features	Benefits	Features	Benefits	Features	Benefits
Rectangular staples	Minimizes staple rotation	Ergonomic pistol grip	Intuitive and comfortable to use	Improved kick-off spring design	Multi-direction release
Head rotates 360°; cartridge is clear	Improves visibility and access	Positive ratchet mechanism	Easy staple placement	Ergonomic design	Comfortable for smaller hands
Staples are coated with lubricant	Easy staple extraction	Staples are coated with lubricant	Easy staple extraction	Alignment indicator	Improves visibility
Pistol-grip handle	Comfortable to use			Staples are coated with lubricant	Easy staple extraction

the staplers are not reloadable. ETHICON Endo-Surgery makes three different skins staplers to meet surgeons' needs.

**PROXIMATE\* PX** skin stapler provides many of the same features as the PROXIMATE RH skin stapler but in a fixed-head format.

**PROXIMATE\* PLUS MD** is a high-value, low-cost skin stapler that permits multi-directional release in an ergonomic design.

## LOOPED SUTURE

ETHICON looped sutures range in length up to a 60-inch strand with both ends swaged to a single taper point needle. Available in various materials and suture sizes, they provide a simple, reliable technique for continuous closure of the fascia of the abdominal wall. The needle of the looped suture is passed through the fascia from inside out at one end of the incision, then through the opposite wound edge from outside in, and then passed through the loop. The locking stitch lies beneath the wound edge. The double strand is run over and over to the other end of the incision. The final stitch is completed by passing the needle from the outside in, cutting one strand, and passing the needle through the opposite wound edge from the outside in. The needle is then cut off and the loose suture ends tied together, leaving the knot inverted under the fascia.



1. Pass the retention suture through appropriate holes in the bridge.



2. Place the suture with tension over the slit in the capstan, and tie.



3. To adjust tension, lift capstan.

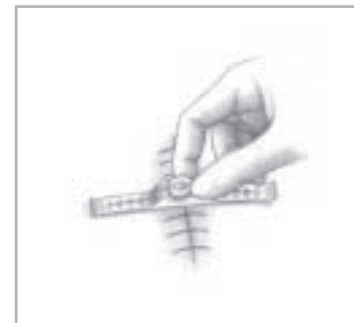

4. Rotate capstan until desired tension is attained.



5. To lock, press capstan down into bridge.

FIGURE 1

## ADJUSTMENT OF RETENTION SUTURE BRIDGE

## RETENTION SUTURE DEVICES

Retention sutures, if not placed carefully without excessive tension, can cut the skin. Devices such as bolsters and bridges are used to prevent such complications and eliminate pressure. However, care should also be taken in the use of these devices.

*Retention suture bolsters* are sterile 2<sup>1</sup>/<sub>2</sub>-inch (6cm) lengths of <sup>3</sup>/<sub>16</sub>-inch

(0.48cm) diameter surgical latex tubing with a <sup>1</sup>/<sub>32</sub>-inch (0.08cm) wall. The suture is threaded through the bolster and tied. Sutures sheathed in this manner can cause an inflammatory response with reaction both at the site of the suture exit from the skin and along the entire length of the suture itself. Also, the skin may become necrotic beneath the bolsters if the sutures are too tight. This invariably occurs if the sutures are tightly tied at the time of the operation, as subsequent tissue edema ensues.

The *retention suture bridge* is a strong plastic truss that can be adjusted to relieve the pressure of the retention suture on the skin during, and subsequent to, initial suture placement. After the desired number of sutures is placed in the wound, a sterile bridge is positioned over each retention suture. Each side of the bridge has six holes spaced  $\frac{1}{4}$  inch (0.64cm) apart to accommodate many patient sizes. The ends of the sutures are passed through the appropriate holes and tied loosely over the bridge. The suture strand is then slipped into the capstan located in the middle of the bridge, and the capstan is rotated to apply the desired tension before locking into place. The bridge permits easy tension readjustment by raising and rotating the capstan to compensate for postoperative wound edema, and again when the edema subsides. The suture remains elevated away from the skin while the bridge has contact along its entire  $4\frac{3}{8}$ -inch (11cm) length. Pressure is evenly distributed over the area, and the transparent bridge facilitates complete visualization of the wound.

## REFERENCES

1. Singer, Adam J., *Lacerations and Acute Wounds, An Evidence-Based Guide*; F.A. Davis Company, ©2003, p. 64-71, 73-82.
2. Skerris, David A., *Mayo Clinic Basic Surgery Skills*, Mayo Clinic Scientific Press, 1999; p.117.

# PRODUCT TERMS AND TRADEMARKS



7-0 (0.5 metric)  
**PROLENE**  
MONOFILAMENT SUTURE  
KIMICO  
MCS  
7-0  
M-2745  
KIMICO



**ABSORBABLE SUTURE**

Sutures which are broken down and eventually absorbed by either hydrolysis (synthetic absorbable sutures) or digestion by lysosomal enzymes elicited by white blood cells (surgical gut and collagen).

**APPROXIMATE**

Bring together sides or edges.

**ATRALOC\*****SURGICAL NEEDLES**

ETHICON\* trademark for eyeless needles permanently attached (swaged) to suture strands.

**B & S GAUGE**

Brown and Sharpe gauge commonly used in hospitals to identify wire diameter. ETHICON stainless steel suture products are labeled with both B & S gauge and U.S.P. size.

**BURIED SUTURE**

Any stitch made and tied so that it remains completely under the surface.

**CALCIFIED CORONARY NEEDLE (CC)**

A TAPERCUT\* surgical needle with a 1/16" cutting tip and slim taper ratio for significant ease of penetration when suturing tough valve cuffs or atherosclerotic vessels.

**CARDIOVASCULAR SUTURES**

Swaged sutures designed to meet the specific needs of heart and blood vessel surgery.

**CATGUT**

Outmoded term for surgical gut suture.

**CHROMIC SURGICAL GUT**

Gut suture which has been treated by chromium salts to resist digestion by lysosomal enzymes.

**CHROMICIZING**

ETHICON process for producing chromic gut. Each ribbon of surgical gut is bathed in a chromium salt solution before spinning into strands to provide uniform controlled absorption.

**COATED VICRYL\*****(POLYGLACTIN 910) SUTURE**

ETHICON trademark for synthetic absorbable suture extruded from a copolymer of glycolide and lactide and coated with a mixture of polyglactin 370 and calcium stearate.

**COATED VICRYL\* Plus ANTIBACTERIAL****(POLYGLACTIN 910) SUTURE**

ETHICON trademark for synthetic absorbable suture extruded from a copolymer of glycolide and lactide (polyglactin 370) and calcium stearate. The first and only suture that protects against bacterial colonization of the suture.

**COATED VICRYL\* RAPIDE (POLYGLACTIN 910) SUTURE**

ETHICON trademark for braided, rapidly absorbing synthetic suture extruded from a copolymer of glycolide and lactide and coated with a mixture of polyglactin 370 and calcium stearate.

**COBALT 60**

Source of irradiation used by ETHICON, INC., to sterilize some suture materials. Also used in hospitals to treat some cancer patients.

**COMPOUND CURVED NEEDLE**

Needle that incorporates two curvatures in one needle: a tight curve at the tip, and a more gradual curve through the body. Used for precise positioning of sutures for comeal/scleral closure and for skin suturing.

**CONTAMINATE**

To cause a sterile object or surface to become unsterile.

**CONTINUOUS SUTURE TECHNIQUE**

Single suture strand passed back and forth between the two edges of the wound to close a tissue layer; tied only at each end of the suture line.

**CONTROL RELEASE\* NEEDLE**

ETHICON trademark for swaging method which permits fast and controlled separation of the needle from the suture material.

**CONVENTIONAL CUTTING NEEDLE**

Needle with triangular point and cutting edge along inner curvature of needle body.

**CORNEAL BEADED RETRACTION SUTURE**

Swaged suture strand with a small bead of epoxy used to elevate cornea for placement of intraocular lens.

**CS ULTIMA\*****OPHTHALMIC NEEDLE (CS)**

ETHICON trademark for needle with reduced side edge angles providing excellent penetration necessary for ophthalmic surgery. Design facilitates knot rotation during surgery.

**CUTICULAR SUTURES**

Sutures designed for skin closure.

**DEAD SPACE**

Pockets left in a tissue layer when tissues are not in close approximation.

**DECONTAMINATION**

Process used to destroy microorganisms known or thought to be present on a surface or object.

**DEHISCENCE**

Total or partial separation of wound edges.

**DERMABOND\*  
TOPICAL SKIN ADHESIVE  
(2-OCTYL CYANOACRYLATE)**

ETHICON trademark for sterile, liquid topical skin adhesive for approximation of wound edges of trauma-induced lacerations or surgical incisions.

**DISPENSER BOXES**

Gravity-fed vertical or horizontal boxes that readily dispense wound closure products. Labels on boxes include product information.

**DOUBLE-ARMED SUTURE**

Suture strand with a needle swaged at each end.

**EASY ACCESS\* PACKAGING**

ETHICON trademark for patented delivery system that presents the needle in position for immediate arming in the needleholder as soon as the primary packet is opened.

**E-PACK\* PROCEDURE KIT**

ETHICON trademark for single overwrapped organizer tray containing multiple ETHICON suture products. Each E-PACK kit may be customized with choice of sutures for specific procedures or surgeon preferences.

**ETHALLOY\* NEEDLE ALLOY**

ETHICON trademark for exclusive patented stainless steel alloy that is 40 percent stronger than needles made of 300 Series stainless steel. Provides improved tissue penetration, smoother needle-to-suture transition, and better flow through tissue.

**ETHIBOND\* EXCEL  
POLYESTER SUTURE**

ETHICON trademark for braided polyester suture coated with polybutylate coating.

**ETHIGUARD\* BLUNT  
POINT NEEDLE**

ETHICON trademark for specially designed needle which has a rounded tip.

**ETHILON\* NYLON SUTURE**

ETHICON trademark for sutures made of monofilament nylon.

**ETHI-PACK\* PRE-CUT SUTURE**

ETHICON trademark for pre-cut strands of nonabsorbable sutures without needles, sterile and nonsterile.

**ETHYLENE OXIDE GAS**

Chemical agent used to sterilize some suture materials.

**EVISCKERATION**

Protrusion of bowel through separated edges of abdominal wound closure.

**EXPIRATION DATE**

Date on a suture product representing the time through which satisfactory stability studies have been carried out.

**EXTRUSION OF KNOTS, KNOT  
EXTRUSION, OR "SPITTING"**

Attempt by the human body to rid itself of nonabsorbable sutures or absorbable sutures which are not completely absorbed ("foreign bodies"). Suture knots encapsulated by cells may work their way to the skin surface months or even years after surgery.

**FASCIA**

Areolar tissue layers under the skin (superficial fascia) or fibrous tissue between muscles and forming the sheaths of muscles or investing other structures such as nerves or blood vessels (deep fascia).

**FDA**

Abbreviation for federal Food and Drug Administration.

**GASTROINTESTINAL SUTURES**

Sutures designed for use in anastomosis of bowel and stomach surgery.

**GAUGE**

Term used to express diameter of suture strand.

**GENERAL CLOSURE SUTURES**

Sutures used in closing fascia, particularly in the abdominal wall. Also for hernia repair and other fascial defects.

**GENTLE BEND\* PACKAGE**

ETHICON trademark for packaging designed to deliver monofilament PROLENE\* polypropylene suture to the surgical field in a straight usable form.

**HEMO-SEAL\* NEEDLE SUTURE**

ETHICON trademark for a needle/suture combination manufactured using a swaging method that provides a smoother needle-to-suture transition. Beneficial in reducing leakage from the suture line, especially in cardiovascular procedures.

**HYDROLYSIS**

Chemical process whereby a compound or polymer reacts with water to cause an alteration or breakdown of the molecular structure. Synthetic absorbable sutures are degraded in vivo by this mechanism.

**INFECTION**

Invasion of body tissue by a pathogen.

**INTERRUPTED SUTURE TECHNIQUE**

Single stitches separately placed, tied, and cut.

**KEITH NEEDLE (KS)**

Straight needle with cutting edges, used primarily for abdominal skin closure. Named for a Scottish surgeon, Dr. Thomas Keith, who made the needle popular.

**KINK**

Undesirable deformation of a strand, such as a sharp bend in wire.

**LABYRINTH\* PACKAGE**

ETHICON trademark for unique package that dispenses straight, kink-free, pre-cut nonabsorbable sutures.

**LIGAPAK\* DISPENSING REEL**

ETHICON trademark for disc-like plastic reel that contains and dispenses suture for ligation.

**LIGAPAK LIGATURE**

ETHICON trademark for a length of suture material wound on a reel, primarily used for ligating.

**LIGATING REEL**

Tube, plastic disc, or other device from which continuous ligating material is unwound as blood vessels are tied.

**LIGATURE**

Strand of material used to tie off a blood vessel.

**LOOPED SUTURE**

Single strand of suture material with both ends swaged onto a single needle.

**MERSILENE\* POLYESTER FIBER MESH**

ETHICON trademark for machine-knitted fabric which is used in hernia repair and other fascial deficiencies that require addition of a reinforcing or bridging material.

**MERSILENE\* POLYESTER FIBER STRIP/TAPE**

ETHICON trademark for a flat band 5mm wide. Useful as a cerclage ligature in patients with an incompetent cervix. Also used for bladder support or repair and support of the rotator cuff in the shoulder.

**MERSILENE\* POLYESTER FIBER SUTURE**

ETHICON trademark for uncoated braided nonabsorbable suture material made of polyester polymer.

**MICRO-POINT\* SPATULA NEEDLE**

ETHICON trademark for side-cutting ophthalmic needles which are thin and flat in profile and specially honed for exceptional sharpness.

**MICRO-POINT\* SURGICAL NEEDLE**

ETHICON trademark for ophthalmic needles which are honed and polished to an extremely fine finish and sharpness.

**MICROSURGERY SUTURES**

Sutures for surgeries in which an operating microscope may be used to visualize the very small structures involved, e.g., blood vessels and nerves.

**MIL**

Unit of linear measurement, equivalent to 0.001 inch. Frequently used to express wire diameter of surgical needles.

**MODULAR SUTURE STORAGE RACK**

Plastic modules of expandable interlocking units that provide neat, convenient storage of ETHICON suture dispenser boxes.

**MONOCRYL\* (POLIGLCAPRONE 25) SUTURE**

ETHICON trademark for monofilament synthetic absorbable suture prepared from a copolymer of glycolide and ε-caprolactone.

**MONOFILAMENT**

A single filament strand.

**MULTIFILAMENT**

Strand made of more than one twisted or braided filament.

**MULTIPASS NEEDLE**

ETHICON trademark for patented coating process that enhances needle performance over multiple penetrations.

**MULTI-STRAND PACKAGE**

Multiple swaged sutures of one type supplied in a single packet.

**NEEDLEHOLDER**

Surgical instrument used to hold and drive a surgical needle during suturing.

**NEEDLE/SUTURE JUNCTION (SWAGE)**

Point at which eyeless needles and suture strands are joined.

**NUROLON\* BRAIDED NYLON SUTURE**

ETHICON trademark for multifilament braided nylon suture.

**NONABSORBABLE SUTURE**

Material which tissue enzymes cannot dissolve. Remains encapsulated when buried in tissues. Removed postoperatively when used as skin suture.

**NYLON**

Synthetic suture material made of polyamide polymer.

**OB-GYN SUTURES**

Needle/suture combinations particularly useful in obstetric and gynecological operations.

**OPHTHALMIC SUTURES**

Small gauge sutures attached to ultrafine needles that meet exacting needs in ophthalmic surgery.

**OVERWRAP**

Exterior packet which protects the sterility of inner suture packet.

**PACKAGE INSERT**

Complete product information inserted in every box of wound closure products, as required by the FDA.

**PC PRIME\* NEEDLE (PC)**

ETHICON trademark for a conventional cutting needle with a geometry that reduces the angle of the cutting edge. Requires less force to penetrate tissue, minimizing tissue trauma in precision cosmetic surgery.

**PDS\* II (POLYDIOXANONE) SUTURE**

ETHICON trademark for monofilament synthetic absorbable suture prepared from the polyester poly (p-dioxanone).

**PERMA-HAND\* SILK SUTURE**

ETHICON trademark for sutures specially processed to remove gum and impurities from raw silk before braiding selected sizes into strands. Also treated with mizmo beeswax to reduce capillarity.

**PLAIN SURGICAL GUT**

Untreated absorbable suture with short-term absorption profile.

**PLASTIC SURGERY SUTURES**

Sutures specifically designed to assist the surgeon in obtaining excellent cosmetic results in plastic and reconstructive surgery.

**PLEDGES**

Small pieces of TFE polymer felt used as a buttress under sutures in cardiovascular surgery.

**POLYBUTILATE**

A nonabsorbable nonreactive polyester lubricant developed by ETHICON, INC., as a coating for ETHIBOND EXCEL sutures.

**POLYESTER FIBER**

Synthetic material made of a polyester polymer of polyethylene terephthalate.

**POLYPROPYLENE**

Synthetic material of an isotactic crystalline stereoisomer of a linear hydrocarbon polymer which will not absorb fluids.

**POLYPROPYLENE BUTTONS**

Synthetic material made into buttons. Useful in orthopaedic procedures such as tendon repair. Sutures are tied over buttons to relieve underlying skin of excessive pressure.



**PRECISION COSMETIC NEEDLE (PC)**

Conventional cutting needles specially polished and carefully honed for aesthetic plastic surgery.

**PRECISION POINT NEEDLE**

Reverse-cutting needles specially polished and carefully honed for plastic surgery.

**PRE-CUT SUTURES**

Strands of suture material packaged pre-cut into various lengths.

**PRIMARY PACKET**

Suture packet which contains the sterile suture.

**PRIMARY WOUND CLOSURE**

The approximation of wound edges to facilitate rapid healing.

**PRODUCT CODE**

Numbers or combination of letters and numbers which identify a specific product.

**PROLENE\* POLYPROPYLENE HERNIA SYSTEM**

ETHICON trademark for a sterile, pre-shaped, three-dimensional device constructed of an onlay patch connected by a mesh cylinder to a circular underlay patch. Used for the repair of indirect and direct inguinal hernia defects.

**PROLENE\* POLYPROPYLENE MESH**

ETHICON trademark for mesh made of polypropylene which is knitted by a process which interlinks each fiber juncture. Used for the repair of abdominal wall defects and tissue deficiencies.

**PROLENE\* POLYPROPYLENE SUTURE**

ETHICON trademark for synthetic nonabsorbable suture material made of monofilament polypropylene.

**PRONOVA\* POLY (HEXAFLUOROPROPYLENE-VDF) SUTURE**

ETHICON trademark for synthetic nonabsorbable suture material made of a polymer blend of poly (vinylidene fluoride) and poly (vinylidene fluoride-cohexafluoropropylene).

**PROXI-STRIP\* SKIN CLOSURES**

ETHICON trademark for adhesive strips used for skin closure.

**RELAY\* SUTURE DELIVERY SYSTEM**

ETHICON trademark for the packaging of single strand and multistrand sutures. Provides delivery of one suture at a time, one-step arming, individual needle parks, and straight, tangle-free sutures ready for use.

**RETENTION SUTURE BOLSTERS**

Surgical tubing used to sheath retention sutures to prevent cutting the skin. Also known as "Booties."

**RETENTION SUTURE BRIDGE**

Clear plastic device designed with a capstan to permit postoperative wound management by adjusting the tension of retention sutures, preventing suture crosshatching on the skin.

**REVERSE CUTTING NEEDLE**

Needles produced by ETHICON Products, which have triangular shapethroughout their entire length and cutting edge along the outside needle curvature to prevent tissue cutout. Needles with longitudinal grooves on the inner and outer flattened curvatures. Ribs engage the needleholder jaw and help to minimize movement of the needle in the needleholder.

**SABRELOC\* SPATULA NEEDLE**

ETHICON trademark for ophthalmic needles. Side-cutting spatula-shaped edges separate the ultrathin layers of scleral or corneal tissue without cutting through.

**SAFETY ORGANIZER TRAY**

ETHICON design for a suture tray which delivers multistrand products. Offers single strand delivery, and a singulated needle park which permits one-step arming and tanglefree straight suture strands.

**SECONDARY CLOSURE**

Retention sutures placed approximately 2 inches from wound edges to reinforce primary closure and protect it from stress.

**SIDE-FLATTENED NEEDLES**

Configuration of stainless steel alloy needles designed to increase strength and reduce bending when penetrating vascular prostheses or calcified tissues.

**SINGLE STRAND DELIVERY**

Terminology used to describe the delivery of one straight suture at a time from the RELAY suture delivery system.



**STERILE**

Free of living microorganisms (bacteria and their spores, viruses, etc.).

**STERILE TECHNIQUE**

Collectively, all the efforts made and procedures followed to exclude microorganisms from the operative wound and field.

**STERILIZATION**

Process by which all living microorganisms on an object are destroyed.

**SUPER-SMOOTH FINISH**

An exclusive process that provides a finish on most ETHICON needles, enabling the needles to penetrate and pass through the toughest tissue with minimal resistance.

**SURGICAL GUT**

Absorbable suture made from serosal layer of beef intestine or submucosal layer of sheep intestine.

**SURGICAL STAINLESS STEEL SUTURE**

Nonabsorbable suture made of 316L steel alloy.

**SUTUPAK\* PRE-CUT STERILE SUTURES**

ETHICON trademark for packet containing multiple pre-cut lengths of suture material without needles, sterile and ready for immediate use.

**SUTURE**

Material used to approximate (sew) tissues or tie off (ligate) blood vessels.

**SUTURE BOOK**

Sterile towel folded by the scrub person and used to contain multiple sutures.

**SWAGED SUTURE**

Strand of material with eyeless needle attached by the manufacturer.

**TAPERCUT\* SURGICAL NEEDLE**

ETHICON trademark for a needle which has a  $1/16$ " triangular tip with three cutting edges. Remainder of needle has a gradually tapered body.

**TAPER POINT NEEDLE (TP)**

Needle with a body that gradually tapers to a sharp point, making the smallest possible hole in tissue.

**TENSILE STRENGTH**

Amount of tension or pull, expressed in pounds, which a suture strand will withstand before it breaks.

**TIES (LIGATURES)**

Strands of suture used to tie off the ends of severed blood vessels: free or freehand—single strands used as individual ties; continuous—long strands unwound from a reel or other device as blood vessels are tied; suture ligature—strand on a needle used to transfix (suture) a large blood vessel to ensure security against knot slippage; stick tie—a suture ligature or a single strand handed to surgeon for ligating with a hemostat clamped on one suture end; transfixion suture—suture ligature.

**TRANSVERSE GROUND NEEDLES (TG)**

Spatulated ophthalmic needles specially honed to a long, sharp, slim tip.

**TRU-GAUGING**

ETHICON process which ensures uniform diameter and uniformly higher tensile strength of surgical gut.

**TRU-PERMANIZING**

ETHICON process of treating silk for noncapillarity.

**TUBING FLUID**

Solution inside packets of surgical gut and collagen. Purpose is to maintain material (and needle, if attached) in optimum condition for immediate use upon withdrawal from the packet.

**UMBILICAL TAPE**

Woven cotton tape, classified as a ligature, used as a gentle means of retracting vessels in cardiovascular and pediatric surgery and for tying off the umbilicus of the newborn.

**UROLOGICAL SUTURES**

Sutures designed to meet the needs of surgery performed by urologists. Features  $5/8$  circle needles which turn out of tissue quickly.

**VICRYL\* (POLYGLACTIN 910) MESH**

ETHICON trademark for mesh prepared from a copolymer of glycolide and lactide. An absorbable material used as a buttress to provide temporary support during healing.

**VICRYL\* (POLYGLACTIN 910)  
PERIODONTAL MESH**

ETHICON trademark for mesh prepared from a copolymer of glycolide and lactide. An absorbable material used in periodontal surgery for guided tissue regeneration.

**VISI-BLACK\* SURGICAL  
NEEDLES**

ETHICON trademark for surgical needles with a black surface finish to enhance visibility in the operative site.

**WOUND DISRUPTION**

Separation of wound edges.

**PRODUCT INFORMATION**



## Coated VICRYL\* (Polyglactin 910) Suture

U.S.P., EXCEPT FOR DIAMETER

### DESCRIPTION

Coated VICRYL\* (polyglactin 910) suture is a synthetic absorbable sterile surgical suture composed of a copolymer made from 90% glycolide and 10% L-lactide. Coated VICRYL suture is prepared by coating VICRYL suture material with a mixture composed of equal parts of copolymer of glycolide and lactide (polyglactin 370) and calcium stearate. Polyglactin 910 copolymer and polyglactin 370 with calcium stearate have been found to be nonantigenic, nonpyrogenic and elicit only a mild tissue reaction during absorption. The sutures are available dyed and undyed (natural).

Coated VICRYL sutures are U.S.P. except for diameters in the following sizes:

#### MAXIMUM SUTURE OVERSIZE IN DIAMETER (mm) FROM U.S.P.

U.S.P. SUTURE SIZE DESIGNATION	MAXIMUM OVERSIZE (mm)
6-0	.008
5-0	.016
4-0	.017
3-0	.018
2-0	.004
0	.022

### INDICATIONS

Coated VICRYL suture is indicated for use in general soft tissue approximation and/or ligation, including use in ophthalmic procedures, but not for use in cardiovascular and neurological tissues.

### ACTIONS

Coated VICRYL suture elicits a minimal acute inflammatory reaction in tissue and ingrowth of fibrous connective tissue. Progressive loss of tensile strength and eventual absorption of coated VICRYL suture occurs by means of hydrolysis, where the copolymer degrades to glycolic and lactic acids which are subsequently absorbed and metabolized in the body. Absorption begins as a loss of tensile strength followed by a loss of mass. Implantation studies in rats indicate that coated VICRYL suture retains approximately 75% of the original tensile strength at two weeks post implantation. At three weeks, approximately 50% of the original strength is retained for sizes 6-0 and larger and approximately 40% of its original strength is retained for sizes 7-0 and smaller. At four weeks, approximately 25% of the original strength is retained for sizes 6-0 and larger. All of the original tensile strength is lost by five weeks post implantation. Absorption of coated VICRYL suture is essentially complete between 56 and 70 days.

#### APPROXIMATE % ORIGINAL

DAYS IMPLANTATION	STRENGTH REMAINING
14 Days	75%
21 Days (6-0 and larger)	50%
21 Days (7-0 and smaller)	40%
28 Days	25%

### CONTRAINDICATIONS

This suture, being absorbable, should not be used where extended approximation of tissue is required.

### WARNINGS

Users should be familiar with surgical procedures and techniques involving absorbable sutures before employing coated VICRYL suture for wound closure, as risk of wound dehiscence may vary with the site of application and the suture material used. Physicians should consider the *in vivo* performance (under ACTIONS section) when selecting a suture. The use of this suture may be inappropriate in elderly, malnourished, or debilitated patients, or in patients suffering from conditions which may delay wound healing. As this is an absorbable suture material, the use of supplemental nonabsorbable sutures should be considered by the surgeon in the closure of the sites which may undergo expansion, stretching or distention, or which may require additional support.

Do not resterilize. Discard opened packages and unused sutures.

As with any foreign body, prolonged contact of any suture with salt solutions, such as those found in the urinary or biliary tracts, may result in calculus formation. As an absorbable suture, coated VICRYL suture may act transiently as a foreign body. Acceptable surgical practice should be followed for the management of contaminated or infected wounds.

### PRECAUTIONS

Skin sutures which must remain in place longer than 7 days may cause localized irritation and should be snipped off or removed as indicated.

Under some circumstances, notably orthopaedic procedures, immobilization of joints by external support may be employed at the discretion of the surgeon.

Consideration should be taken in the use of absorbable sutures in tissues with poor blood supply as suture extrusion and delayed absorption may occur.

In handling this or any other suture material, care should be taken to avoid damage from handling. Avoid crushing or crimping damage due to application of surgical instruments such as forceps or needle holders. Coated VICRYL sutures, which are treated to enhance handling characteristics, require the accepted surgical technique of flat and square ties with additional throws as warranted by surgical circumstance and the experience of the surgeon.

Avoid prolonged exposure to elevated temperatures.

To avoid damaging needle points and swage areas, grasp the needle in an area one-third (1/3) to one-half (1/2) of the distance from the swaged end to the point. Reshaping needles may cause them to lose strength and be less resistant to bending and breaking. Users should exercise caution when handling surgical needles to avoid inadvertent needle sticks. Discard used needles in "sharps" container.

### ADVERSE REACTIONS

Adverse effects associated with the use of this device include wound dehiscence, failure to provide adequate wound support in closure of the sites where expansion, stretching, or distension occur, failure to provide adequate wound support in elderly, malnourished or debilitated patients or in patients suffering from conditions which may delay wound healing, infection, minimal acute inflammatory tissue reaction, localized irritation when skin sutures are left in place for greater than 7 days, suture extrusion and delayed absorption in tissue with poor blood supply, calculi formation in urinary and biliary tracts when prolonged contact with salt solutions such as urine and bile occurs, and transitory local irritation at the wound site. Broken needles may result in extended or additional surgeries or residual foreign bodies. Inadvertent needle sticks with contaminated surgical needles may result in the transmission of bloodborne pathogens.

### HOW SUPPLIED

Coated VICRYL sutures are available sterile, as braided dyed (violet) and undyed (natural) strands in sizes 8-0 through 3 (metric sizes 0.4-6), in a variety of lengths, with or without needles, and on LIGAPAK\* dispensing reels.

Coated VICRYL sutures are also available in size 8-0 with attached beads for use in ophthalmic procedures. Coated VICRYL sutures are also available in sizes 4-0 through 2 (metric sizes 1.5-5.0) attached to CONTROL RELEASE\* removable needles. Coated VICRYL sutures are available in one, two, and three dozen boxes.

389389

\*Trademark

©ETHICON, INC. 1996

## ETHILON\* NYLON SUTURE

### NONABSORBABLE SURGICAL SUTURES, U.S.P.

#### DESCRIPTION

ETHILON\* nylon suture is a nonabsorbable, sterile surgical monofilament suture composed of the long-chain aliphatic polymers Nylon 6 and Nylon 6,6. ETHILON sutures are dyed black or green to enhance visibility in tissue. The suture is also available undyed (clear).

ETHILON suture meets all requirements established by the United States Pharmacopoeia (U.S.P.) for nonabsorbable surgical suture.

#### INDICATIONS

ETHILON suture is indicated for use in general soft tissue approximation and/or ligation, including use in cardiovascular, ophthalmic and neurological procedures.

#### ACTIONS

ETHILON suture elicits a minimal acute inflammatory reaction in tissue, which is followed by gradual encapsulation of the suture by fibrous connective tissue. While nylon is not absorbed, progressive hydrolysis of the nylon *in vivo* may result in gradual loss over time of tensile strength.

#### CONTRAINDICATIONS

Due to the gradual loss of tensile strength which may occur over prolonged periods *in vivo*, nylon suture should not be used where permanent retention of tensile strength is required.

#### WARNINGS

Users should be familiar with surgical procedures and techniques involving nonabsorbable sutures before employing ETHILON suture for wound closure, as the risk of wound dehiscence may vary with the site of application and the suture material used.

As with any foreign body, prolonged contact of any suture with salt solutions, such as those found in the urinary or biliary tracts, may result in calculus formation. Acceptable surgical practice should be followed for the management of contaminated or infected wounds.

Do not resterilize. Discard open packages and unused sutures.

#### PRECAUTIONS

In handling this or any other suture material, care should be taken to avoid damage from handling. Avoid crushing or crimping damage due to application of surgical instruments such as forceps or needle holders.

As with any suture material, adequate knot security requires the accepted surgical technique of flat and square ties, with additional throws as warranted by surgical circumstance and the experience of the surgeon. The use of additional throws may be particularly appropriate when knotting monofilaments.

To avoid damaging needle points and swage areas, grasp the needle in an area one-third (1/3) to one-half (1/2) of the distance from the swaged end to the point. Reshaping needles may cause them to lose strength and be less resistant to bending and breaking. Users should exercise caution when handling surgical needles to avoid inadvertent needle sticks. Discard used needles in "sharps" containers.

#### ADVERSE REACTIONS

Adverse effects associated with the use of this device include wound dehiscence, gradual loss of tensile strength over time, calculi formation in urinary and biliary tracts when prolonged contact with salt solutions such as urine and bile occurs, infection, minimal acute inflammatory tissue reaction, and transitory local irritation at the wound site. Broken needles may result in extended or additional surgeries or residual foreign bodies. Inadvertent needle sticks with contaminated surgical needles may result in the transmission of bloodborne pathogens.

#### HOW SUPPLIED

ETHILON sutures are available as sterile monofilament strands in U.S.P. sizes 11-0 through 2 (metric sizes 0.1-5.0) in a variety of lengths, with and without permanently attached needles. ETHILON sutures are available in one, two and three dozen boxes.

389355

\*Trademark

©ETHICON, INC. 1995



## Coated VICRYL\* *RAPIDE* (Polyglactin 910) Braided Coated Synthetic Absorbable Suture, Undyed

Non-U.S.P.

### DESCRIPTION

Coated VICRYL\* *RAPIDE* (polyglactin 910) suture is a synthetic absorbable sterile surgical suture composed of a copolymer made from 90% glycolide and 10% L-lactide. The empirical formula of the copolymer is  $(C_2H_2O_2)_m(C_3H_4O_2)_n$ . The characteristic of rapid loss of strength is achieved by use of a polymer material with a lower molecular weight than coated VICRYL\* (polyglactin 910) suture.

Coated VICRYL *RAPIDE* sutures are obtained by coating the braided suture material with a mixture composed of equal parts of copolymer of glycolide and lactide (polyglactin 370) and calcium stearate. Polyglactin 910 copolymer and polyglactin 370 with calcium stearate have been found to be nonantigenic, nonpyrogenic and elicit only a mild tissue reaction during absorption.

Coated VICRYL *RAPIDE* sutures are only available undyed.

Although this suture is a synthetic absorbable suture, its performance characteristics are intended to model the performance of collagen (surgical gut) suture. The knot tensile strength of coated VICRYL *RAPIDE* suture meets U.S.P. knot tensile strength requirements for collagen sutures, however, Coated VICRYL *RAPIDE* suture strength is up to 26% less than knot tensile strength requirements for synthetic absorbable sutures.

#### MAXIMUM SUTURE OVERSIZE IN DIAMETER (mm) FROM U.S.P.

U.S.P. SUTURE SIZE DESIGNATION	MAXIMUM OVERSIZE(mm)
5-0	.016
4-0	.017
3-0	.018
2-0	.010
0	.022

### INDICATIONS

Coated VICRYL *RAPIDE* synthetic absorbable suture is indicated only for use in superficial soft tissue approximation of the skin and mucosa, where only short term wound support (7-10 days) is required. Coated VICRYL *RAPIDE* suture is not intended for use in ligation, ophthalmic, cardiovascular or neurological procedures.

### ACTIONS

Coated VICRYL *RAPIDE* suture, when used in closure of skin and mucous membranes, typically begins to fall off 7-10 days post-operatively and can be wiped off subsequently with sterile gauze. Natural mechanical abrasion of the sutures while in situ may also accelerate this disappearance rate. Rapid loss of tensile strength may preclude the need for stitch removal.

Coated VICRYL *RAPIDE* elicits a minimal to moderate acute inflammatory reaction in tissue. Progressive loss of tensile strength and eventual absorption of coated VICRYL *RAPIDE* occurs by means of hydrolysis, where the copolymer degrades to glycolic and lactic acids which are subsequently absorbed and metabolized in the body. Absorption begins as a loss of tensile strength followed by a loss of mass.

Subcutaneous tissue implantation studies of coated VICRYL *RAPIDE* sutures in rats show that 5 days post-implantation approximately 50% of the original tensile strength remains. All of the original tensile strength is lost by approximately 10 to 14 days post-implantation. Intramuscular implantation studies in rats show that the absorption of these sutures occurs thereafter and is essentially complete by 42 days.

### CONTRAINDICATIONS

Due to the rapid loss of tensile strength, this suture should not be used where extended approximation of tissues under stress is required or where wound support beyond 7 days is required.

### WARNINGS

Users should be familiar with surgical procedures and techniques involving absorbable sutures before employing coated VICRYL *RAPIDE* suture for wound closure, as a risk of wound dehiscence may vary with the site of application and the suture material used. Physicians should consider the *in vivo* performance when selecting a suture. The use of this suture may be inappropriate in elderly, malnourished, or debilitated patients, or in patients suffering from conditions which may delay wound healing.

Do not resterilize. Discard opened packages and unused sutures.

As with any foreign body, prolonged contact of any suture with salt solutions, such as those found in the urinary or biliary tracts, may result in calculus formation. As an absorbable suture, coated VICRYL *RAPIDE* suture may act transiently as a foreign body.

Acceptable surgical practice should be followed for the management of contaminated or infected wounds.

As this is an absorbable suture material, the use of supplemental nonabsorbable sutures should be considered by the surgeon in the closure of sites which may undergo expansion, stretching or distention, or which may require additional support.

### PRECAUTIONS

Skin sutures which remain in place longer than 7 days may cause localized irritation and should be snipped off or removed as indicated.

Under some circumstances, notably orthopaedic procedures, immobilization of joints by external support may be employed at the discretion of the surgeon.

Consideration should be taken in the use of absorbable sutures in tissues with poor blood supply as suture extrusion and delayed absorption may occur.

In handling this or any other suture material, care should be taken to avoid damage from handling. Avoid crushing or crimping damage due to application of surgical instruments such as forceps or needle holders.

Coated VICRYL *RAPIDE* suture, which is treated with coating to enhance handling characteristics, requires the accepted surgical technique of flat and square ties with additional throws as warranted by surgical circumstance and the experience of the surgeon.

Avoid prolonged exposure to elevated temperatures.

To avoid damaging needle points and swage areas, grasp the needle in an area one-third (1/3) to one-half (1/2) of the distance from the swaged end to the point. Reshaping needles may cause them to lose strength and be less resistant to bending and breaking.

Users should exercise caution when handling surgical needles to avoid inadvertent needle sticks. Discard used needles in "sharps" containers.

### ADVERSE REACTIONS

Adverse effects associated with the use of this device include wound dehiscence, failure to provide adequate wound support in closure of the sites where expansion, stretching, or distension occur, failure to provide adequate wound support in elderly, malnourished or debilitated patients or in patients suffering from conditions which may delay wound healing, infection, minimal acute inflammatory tissue reaction, localized irritation when skin sutures are left in place for greater than 7 days, suture extrusion and delayed absorption in tissue with poor blood supply, calculi formation in urinary and biliary tracts when prolonged contact with salt solutions such as urine and bile occurs, and transitory local irritation at the wound site. Broken needles may result in extended or additional surgeries or residual foreign bodies. Inadvertent needle sticks with contaminated surgical needles may result in the transmission of bloodborne pathogens.

### HOW SUPPLIED

Coated VICRYL *RAPIDE* sutures are available sterile, undyed and attached to stainless steel needles of varying types and sizes.

Coated VICRYL *RAPIDE* sutures are available in various lengths in sizes 5-0 to 1 (1.0 to 4.0 metric) in one and three dozen boxes.

389307

\*Trademark

©ETHICON, INC. 1994

## DERMABOND®

Topical Skin Adhesive  
(2-Octyl Cyanoacrylate)

### INDICATION

DERMABOND® Topical Skin Adhesive is intended for topical application only to hold closed evenly approximated skin edges of wounds from surgical incisions, including punctures from minimally invasive surgery, and simple, thoroughly debrided, trauma-induced lacerations. DERMABOND® adhesive may be used in conjunction with, but not in place of, deep suture closure.

### CONTRAINDICATIONS

- Do not use on any wound with evidence of active infection, gangrene, or wounds of decubitus etiology.
- Do not use on mucosal surfaces or across mucocutaneous junctions (e.g., oral cavity, lips), or on skin which may be regularly exposed to body fluids or with dense natural hair (e.g., scalp).
- Do not use on patients with a known hypersensitivity to cyanoacrylate or formaldehyde.

### WARNINGS

- DERMABOND® adhesive is a fast setting adhesive capable of adhering to most body tissue and many other materials, such as latex gloves and stainless steel. Inadvertent contact with any body tissue and any surfaces or equipment that are not disposable or that cannot be readily cleaned with a solvent such as acetone should be avoided.
- Polymerization of DERMABOND® adhesive may be accelerated by water or fluids containing alcohol. DERMABOND® adhesive should not be applied to wet wounds.
- DERMABOND® adhesive should not be applied to the eye. If contact with the eye occurs, flush the eye copiously with saline or water. If needs of adhesive remains, apply topical ophthalmic anesthetic to help loosen the bond and contact an ophthalmologist.
- When closing facial wounds near the eye with DERMABOND® adhesive, position the patient so that any run-off of adhesive is away from the eye. The eye should be closed and protected with gauze. Prophylactic placement of petroleum jelly around the eye, to act as a mechanical barrier or dam, can be effective in preventing inadvertent flow of adhesive into the eye. DERMABOND® adhesive will not adhere to silicon-coated anti-petroleum jelly. Therefore, avoid using petroleum jelly on any areas where DERMABOND® adhesive is intended to adhere. Use of DERMABOND® adhesive near the eye has inadvertently caused some patients' eyelids to be sealed shut. In some of these cases, general anesthesia and surgical removal has been required to open the eyelid.
- DERMABOND® adhesive should not be used below the skin because the polymerized material is not absorbed by tissue and can elicit a foreign body reaction.
- DERMABOND® adhesive should not be used in high skin tension areas or across areas of increased skin tension, such as incisions, abrasions, or lacerations, unless the part will be immobilized during the skin healing period.
- DERMABOND® adhesive treated wounds should be monitored for signs of infection. Wounds with signs of infection, such as erythema, edema, warmth, pain and pus, should be evaluated and treated according to standard practice for infection.
- DERMABOND® adhesive should not be used on wound sites that will be subjected to repeated or prolonged moisture or friction.
- DERMABOND® adhesive should only be used after wounds have been debrided and debrided in accordance with standard surgical practice. Local anesthetic should be used when necessary to ensure adequate cleaning and debridement.
- Excessive pressure of the applicator tip against wound edges or surrounding skin can force the wound edges apart and allow adhesive into the wound. Adhesive within the wound could delay wound healing and/or result in adverse cosmetic outcomes. Therefore, DERMABOND® adhesive should be applied with a very light loading motion of the applicator tip over evenly approximated wound edges.
- DERMABOND® adhesive polymerizes through an exothermic reaction in which a small amount of heat is released. With the proper technique of applying DERMABOND® adhesive in multiple thin layers (at least three) onto a dry wound and allowing time for polymerization between applications, heat is released slowly and the sensation of heat or pain experienced by the patient is minimized. However, if DERMABOND® adhesive is applied so that large droplets of liquid are not allowed to remain unspread, the patient may experience a sensation of heat or discomfort.
- DERMABOND® adhesive is packaged for single patient use. Discard remaining opened material after each wound closure procedure.
- Do not reutilize DERMABOND® adhesive.
- Do not place DERMABOND® adhesive in its procedure pack, tray that it is to be sterilized prior to use. Exposure of DERMABOND® adhesive, after its final manufacture, to excessive heat (as in autoclaves or ethylene oxide sterilization) or radiation (such as gamma or electron beams), is known to increase its viscosity and may render the product unusable.

### PRECAUTIONS

- Do not apply liquid or ointment medications or other substances to the wound after closure with DERMABOND® adhesive, as these substances can weaken the polymerized film and allow for wound dehiscence. DERMABOND® adhesive permeability by topical medications has not been studied.
- DERMABOND® adhesive permeability by fluids is not known and has not been studied.
- DERMABOND® adhesive is a free flowing liquid slightly more viscous than water. To prevent inadvertent flow of liquid DERMABOND® adhesive to unintended areas: (1) the wound should be held in a horizontal position with DERMABOND® adhesive applied from above, and (2) DERMABOND® adhesive should be applied in multiple (at least 3), thin layers rather than in a few large droplets.
- Hold applicator away from yourself and the patient and break ampule close to its center one time only. Do not crush the contents of the applicator tube repeatedly as further manipulation of the applicator may cause glass shard penetration of the outer tube.
- DERMABOND® adhesive should be used immediately after creating the glass ampule as the liquid adhesive will not flow freely from the applicator tip after a few minutes.
- Unintended bonding of intact skin occurs, but do not pull the skin apart. Petroleum jelly or acetone may help loosen the bond. Other agents such as water, saline, Betadine® Antiseptic, HEGLUM® (hydroxyethyl glucoside), or soap are not expected to immediately loosen the bond.
- Safety and effectiveness of DERMABOND® adhesive on wounds of patients with peripheral vascular disease, insulin dependent diabetes mellitus, blood clotting disorders, personal or family history of keloid formation or hypertrophy, or burn related lacerations, have not been studied.
- Safety and effectiveness of DERMABOND® adhesive on the following wounds have not been studied: animal or human bites, puncture or stab wounds.

Clinical Study Settings	No Subcutaneous Sutures		With Subcutaneous Sutures	
	DERMABOND®	Control	DERMABOND®	Control
	8 (1%)	8 (1%)	8 (1%)	8 (1%)
<b>Adverse Events</b>				
• Patients required	203	203	207	198
• Patients treated	204	202	207	198
• Patients completed	126 (61%)	115 (57%)	141 (68%)	102 (52%)
<b>Adverse Reactions</b>				
• Suspected infection*	8 (3.9%)	11 (5.4%)	8 (3.9%)	11 (5.5%)
• Patient type				
• Inpatient	0	2	1	0
• Outpatient	0	0	0	0
<b>Adhesive with Heat or Discomfort</b>	0 (0.0%)	0 (0.0%)	4 (1.9%)	0
<b>Adverse Adhesions</b>				
• Cellulitis	26 (12.7%)	31 (15.3%)	32 (15.4%)	25 (12.6%)
• Erysipelas	27 (13.2%)	26 (12.8%)	42 (20.3%)	21 (10.6%)
• Pain	14 (6.8%)	15 (7.4%)	36 (17.4%)	37 (18.2%)
• Numbness	1 (0.5%)	6 (2.9%)	1 (0.5%)	4 (2.0%)

- Safety and effectiveness on wounds that have been treated with DERMABOND® adhesive and then exposed for prolonged periods to direct sunlight or tanning lamps have not been studied.
- Safety and effectiveness of DERMABOND® adhesive on wounds in venereal surfaces has not been studied.

### ADVERSE REACTIONS

- Adverse reactions encountered during clinical study:
  - In the clinical study, presence of infection may be identified by observation of redness or pain that is 3-5 mm from the repaired wound, swelling, purulent discharge, pain, increased skin temperature, fever, or other systemic signs of infection. (See clinical study.) Confirmatory culture was not routinely obtained. Any signs of suspected infection for DERMABOND® adhesive, 7.14 (3.5%) were in patients less than 12 years old with traumatic lacerations; overall, 8 of the 14 (approximately 57%) DERMABOND® adhesive wounds with suspected infections were associated with sub-optimal cosmetic outcomes.
  - Reactions may occur in patients who are hypersensitive to cyanoacrylate or formaldehyde. See CONTRAINDICATIONS.
  - The polymerization of DERMABOND® adhesive on the skin releases small amounts of heat which may cause a sensation of heat or discomfort in some patients.
  - Adverse reactions may be expected following DERMABOND® adhesive contact with the eye.

Manufactured by ETHICON, INC.  
by Covidien Medical Corp.  
\*Trademark © ETHICON, INC. 1999

®Trademark of Purdue Frederick  
®Registered Trademark of Zimex Pharmaceuticals

### High Viscosity

## DERMABOND®

Topical Skin Adhesive  
(2-Octyl Cyanoacrylate)

### INDICATION

High viscosity DERMABOND® Topical Skin Adhesive is intended for topical application only to hold closely and evenly approximated skin edges of wounds from surgical incisions, including punctures from minimally invasive surgery, and simple, thoroughly debrided, trauma-induced lacerations. High viscosity DERMABOND® adhesive may be used in conjunction with, but not in place of, deep suture closure.

### CONTRAINDICATIONS

- Do not use on any wound with evidence of active infection, gangrene, or wounds of decubitus etiology.
- Do not use on mucosal surfaces or across mucocutaneous junctions (e.g., oral cavity, lips), or on skin which may be regularly exposed to body fluids or with dense natural hair (e.g., scalp).
- Do not use on patients with a known hypersensitivity to cyanoacrylate or formaldehyde.

### WARNINGS

- High viscosity DERMABOND® adhesive is a fast setting adhesive capable of adhering to most body tissue and many other materials, such as latex gloves and stainless steel. Inadvertent contact with any body tissue and any surfaces or equipment that are not disposable or that cannot be readily cleaned with a solvent such as acetone should be avoided.
- Polymerization of high viscosity DERMABOND® adhesive may be accelerated by water or fluids containing alcohol. High viscosity DERMABOND® adhesive should not be applied to wet wounds.
- High viscosity DERMABOND® adhesive should not be applied to the eye. If contact with the eye occurs, flush the eye copiously with saline or water. If medical adhesive remains, apply topical ophthalmic anesthetic to help loosen the bond and contact an ophthalmologist.
- When closing facial wounds near the eye with high viscosity DERMABOND® adhesive, position the patient so that any run-off of adhesive is away from the eye. The eye should be closed and protected with gauze. Prophylactic placement of petroleum jelly around the eye, to act as a mechanical barrier or dam, can be effective in preventing inadvertent flow of adhesive into the eye. High viscosity DERMABOND® adhesive will not adhere to silicon-coated anti-petroleum jelly. Therefore, avoid using petroleum jelly on any areas where high viscosity DERMABOND® adhesive is intended to adhere. Use of high viscosity DERMABOND® adhesive near the eye has inadvertently caused some patients' eyelids to be sealed shut. In some of these cases, general anesthesia and surgical removal has been required to open the eyelid.
- High viscosity DERMABOND® adhesive should not be used below the skin because the polymerized material is not absorbed by tissue and can elicit a foreign body reaction.
- High viscosity DERMABOND® adhesive should not be used in high skin tension areas or across areas of increased skin tension, such as incisions, abrasions, or lacerations, unless the part will be immobilized during the skin healing period.
- High viscosity DERMABOND® adhesive treated wounds should be monitored for signs of infection. Wounds with signs of infection, such as erythema, edema, warmth, pain and pus, should be evaluated and treated according to standard practice for infection.
- High viscosity DERMABOND® adhesive should not be used on wound sites that will be subjected to repeated or prolonged moisture or friction.
- High viscosity DERMABOND® adhesive should only be used after wounds have been debrided and debrided in accordance with standard surgical practice. Local anesthetic should be used when necessary to ensure adequate cleaning and debridement.
- Excessive pressure of the applicator tip against wound edges or surrounding skin can force the wound edges apart and allow adhesive into the wound. Adhesive within the wound could delay wound healing and/or result in adverse cosmetic outcomes. Therefore, high viscosity DERMABOND® adhesive should be applied with a very light loading motion of the applicator tip over evenly approximated wound edges.
- High viscosity DERMABOND® adhesive polymerizes through an exothermic reaction in which a small amount of heat is released. With the proper technique of applying high viscosity DERMABOND® adhesive in multiple thin layers (at least three) onto a dry wound and allowing time for polymerization between applications, heat is released slowly and the sensation of heat or pain experienced by the patient is minimized. However, if high viscosity DERMABOND® adhesive is applied so that large droplets of liquid are not allowed to remain unspread, the patient may experience a sensation of heat or discomfort.
- High viscosity DERMABOND® adhesive is packaged for single patient use. Discard remaining opened material after each wound closure procedure.
- Do not reutilize high viscosity DERMABOND® adhesive.
- Do not place high viscosity DERMABOND® adhesive in its procedure pack/tray that it is to be sterilized prior to use. Exposure of high viscosity DERMABOND® adhesive, after its final manufacture, to excessive heat (as in autoclaves or ethylene oxide sterilization) or radiation (such as gamma or electron beams), is known to increase its viscosity and may render the product unusable.

### PRECAUTIONS

- High viscosity DERMABOND® adhesive has not been evaluated for use on wounds such as surgical incisions, punctures from minimally invasive surgery.
- Do not apply liquid or ointment medications or other substances to the wound after closure with high viscosity DERMABOND® adhesive, as these substances can weaken the polymerized film and allow for wound dehiscence. High viscosity DERMABOND® adhesive permeability by topical medications has not been studied.
- High viscosity DERMABOND® adhesive permeability by fluids is not known and has not been studied.
- High viscosity DERMABOND® adhesive is a free flowing liquid, is more viscous than water. To prevent inadvertent flow of liquid high viscosity DERMABOND® adhesive to unintended areas: (1) the wound should be held in a horizontal position, with high viscosity DERMABOND® adhesive applied from above, and (2) high viscosity DERMABOND® adhesive should be applied in multiple (at least 3), thin layers rather than in a few large droplets.
- Hold applicator away from yourself and the patient and break ampule close to its center one time only. Do not crush the contents of the applicator tube repeatedly as further manipulation of the applicator may cause glass shard penetration of the outer tube.
- High viscosity DERMABOND® adhesive should be used immediately after creating the glass ampule as the liquid adhesive will not flow freely from the applicator tip after a few minutes.
- Unintended bonding of intact skin occurs, but do not pull the skin apart. Petroleum jelly or acetone may help loosen the bond. Other agents such as water, saline, Betadine® Antiseptic, HEGLUM® (hydroxyethyl glucoside), or soap are not expected to immediately loosen the bond.
- Safety and effectiveness of high viscosity DERMABOND® adhesive on wounds of patients with peripheral vascular disease, insulin dependent diabetes mellitus, blood clotting disorders, personal or family history of keloid formation or hypertrophy, or burn related lacerations, have not been studied.
- Safety and effectiveness of high viscosity DERMABOND® adhesive on the following wounds have not been studied: animal or human bites, puncture or stab wounds.
- Safety and effectiveness on wounds that have been treated with high viscosity DERMABOND® adhesive and then exposed for prolonged periods to direct sunlight or tanning lamps have not been studied.
- Safety and effectiveness of high viscosity DERMABOND® adhesive on wounds in venereal surfaces has not been studied.

### ADVERSE REACTIONS

- Adverse reactions encountered during the clinical study for closure of trauma-induced lacerations using high viscosity DERMABOND® adhesive and the clinical study comparing low viscosity DERMABOND® adhesive to sutures, staples, and adhesive strips are listed below:
  - The safety of both high viscosity DERMABOND® adhesive and the low viscosity DERMABOND® adhesive control was assessed in a randomized clinical study of 24 patients, 42 patients receiving high viscosity product and 42 receiving low viscosity product. (1) The presence or the extent of an inflammatory reaction, (2) the presence of signs of clinical infection, (3) cosmetic outcomes at Day 30, (4) assessment of thermal discomfort, and (5) the reported adverse events associated with use of the device. No significant differences between the two treatment groups were observed for any of these safety outcome measures, although 17 patients (41%) within each of the high viscosity DERMABOND® adhesive treatment group experienced a sensation of heat or application of the skin adhesive compared to 18 patients (25%) randomized to the low viscosity DERMABOND® adhesive treatment group. Of these 17 patients in the high viscosity group, 5 of the patients noted that sensation of heat was uncomfortable. None of the patients in the low viscosity group showed objective evidence of heat.

As indicated under WARNINGS, high viscosity DERMABOND® adhesive polymerizes through an exothermic reaction in which heat is released. It is important to use the proper technique of applying high viscosity DERMABOND® adhesive in the layers to minimize the risk that the patient may experience a sensation of heat or discomfort. This is especially important in the application of high viscosity DERMABOND® adhesive because the increased viscosity of the product relative to low viscosity DERMABOND® adhesive can result in thicker applied layer resulting in a higher potential for heat to be generated. High viscosity DERMABOND® adhesive should always be applied in thin layers so that large amounts of liquid are not allowed to collect, resulting in thermal discomfort for the patient.

Adverse reactions encountered during clinical study comparing low viscosity DERMABOND® adhesive to sutures, staples, and adhesive strips are listed in the table to the left.

- Reactions may occur in patients who are hypersensitive to cyanoacrylate or formaldehyde. See CONTRAINDICATIONS.
- Adverse reactions may be experienced following high viscosity DERMABOND® adhesive contact with the eye.

Manufactured by ETHICON, INC.  
by Covidien Medical Corp.  
\*Trademark © ETHICON, INC. 2002  
®Trademark of Purdue Frederick  
®Registered Trademark of Zimex Pharmaceuticals



**ETHIBOND\* EXCEL POLYESTER SUTURE**

NONABSORBABLE SURGICAL SUTURE, U.S.P.  
Except for size 6-0 diameter

**DESCRIPTION**

ETHIBOND\* EXCEL polyester suture is a nonabsorbable, braided, sterile, surgical suture composed of Poly (ethylene terephthalate). It is prepared from fibers of high molecular weight, long-chain, linear polyesters having recurrent aromatic rings as an integral component. ETHIBOND EXCEL suture is uniformly coated with polybutylate or poly {oxy-1, 4 butanediyl oxy (1, 6-dioxo-1, 6 hexanediyl)}. The highly adherent coating is a relatively nonreactive nonabsorbable compound which acts as a lubricant to mechanically improve the physical properties of the uncoated suture by improving ease of passage through tissues and by providing overall improved handling qualities as contrasted to the braided, uncoated fiber.

ETHIBOND EXCEL sutures are braided for optimal handling properties, and for good visibility in the surgical field, are dyed green.

Size 6-0 ETHIBOND EXCEL sutures are U.S.P., except for diameter.

MAXIMUM SUTURE OVERSIZE IN DIAMETER (mm) FROM U.S.P.	
U.S.P. SUTURE SIZE DESIGNATION	MAXIMUM OVERSIZE (mm)
6-0	0.024

**INDICATIONS**

ETHIBOND EXCEL suture is indicated for use in general soft tissue approximation and/or ligation, including use in cardiovascular, ophthalmic and neurological procedures.

**ACTIONS**

ETHIBOND EXCEL suture elicits a minimal acute inflammatory reaction in tissue, followed by a gradual encapsulation of the suture by fibrous connective tissue. Implantation studies in animals show no meaningful decline in polyester suture strength over time. Both polyester fiber suture material and the polybutylate coating are pharmacologically inactive.

**CONTRAINDICATIONS**

None known.

**WARNINGS**

Users should be familiar with surgical procedures and techniques involving nonabsorbable sutures before employing ETHIBOND EXCEL suture for wound closure, as risk of wound dehiscence may vary with the site of application and the suture material used.

Do not resterilize. Discard opened packages and unused sutures.

As with any foreign body, prolonged contact of any suture with salt solutions, such as those found in the urinary or biliary tracts, may result in calculus formation. Acceptable surgical practice should be followed for the management of infected or contaminated wounds.

**PRECAUTIONS**

In handling this or any other suture material, care should be taken to avoid damage from handling. Avoid crushing or crimping damage due to application of surgical instruments such as forceps or needle holders.

As with any suture material, adequate knot security requires the accepted surgical technique of flat and square ties with additional throws as warranted by surgical circumstance and the experience of the surgeon.

To avoid damaging needle points and swage areas, grasp the needle in an area one-third (1/3) to one-half (1/2) of the distance from the swaged end to the point. Reshaping needles may cause them to lose strength and be less resistant to bending and breaking. Users should exercise caution when handling surgical needles to avoid inadvertent needle sticks. Discard used needles in "sharps" containers.

**ADVERSE REACTIONS**

Adverse effects associated with the use of this device include wound dehiscence, calculi formation in urinary and biliary tracts when prolonged contact with salt solutions such as urine and bile occurs, infection, minimal acute inflammatory tissue reaction and transitory local irritation at the wound site. Broken needles may result in extended or additional surgeries or residual foreign bodies. Inadvertent needle sticks with contaminated surgical needles may result in the transmission of bloodborne pathogens.

**HOW SUPPLIED**

ETHIBOND EXCEL sutures are available as sterile, braided, green and undyed (white) strands in sizes 7-0 through 5 (metric sizes 0.5-7) in a variety of lengths, with and without permanently attached needles.

ETHIBOND EXCEL sutures, green, braided, in sizes 4-0 through 1 (metric sizes 1.5-4) are also available attached to CONTROL RELEASE\* removable needles.

ETHIBOND EXCEL sutures, green and undyed, are also available attached to TFE polymer pledgets measuring 1/8" x 1/8" x 1/16" (3.0mm x 3.0mm x 1.5mm), 1/4" x 1/8" x 1/16" (7.0mm x 3.0mm x 1.5mm).

ETHIBOND EXCEL sutures are available in one, two and three dozen boxes.

389397 \*Trademark ©ETHICON,INC. 1996

## ETHILON\* NYLON SUTURE

### NONABSORBABLE SURGICAL SUTURES, U.S.P.

#### DESCRIPTION

ETHILON\* nylon suture is a nonabsorbable, sterile surgical monofilament suture composed of the long-chain aliphatic polymers Nylon 6 and Nylon 6,6. ETHILON sutures are dyed black or green to enhance visibility in tissue. The suture is also available undyed (clear).

ETHILON suture meets all requirements established by the United States Pharmacopoeia (U.S.P.) for nonabsorbable surgical suture.

#### INDICATIONS

ETHILON suture is indicated for use in general soft tissue approximation and/or ligation, including use in cardiovascular, ophthalmic and neurological procedures.

#### ACTIONS

ETHILON suture elicits a minimal acute inflammatory reaction in tissue, which is followed by gradual encapsulation of the suture by fibrous connective tissue. While nylon is not absorbed, progressive hydrolysis of the nylon *in vivo* may result in gradual loss over time of tensile strength.

#### CONTRAINDICATIONS

Due to the gradual loss of tensile strength which may occur over prolonged periods *in vivo*, nylon suture should not be used where permanent retention of tensile strength is required.

#### WARNINGS

Users should be familiar with surgical procedures and techniques involving nonabsorbable sutures before employing ETHILON suture for wound closure, as the risk of wound dehiscence may vary with the site of application and the suture material used.

As with any foreign body, prolonged contact of any suture with salt solutions, such as those found in the urinary or biliary tracts, may result in calculus formation. Acceptable surgical practice should be followed for the management of contaminated or infected wounds.

Do not resterilize. Discard open packages and unused sutures.

#### PRECAUTIONS

In handling this or any other suture material, care should be taken to avoid damage from handling. Avoid crushing or crimping damage due to application of surgical instruments such as forceps or needle holders.

As with any suture material, adequate knot security requires the accepted surgical technique of flat and square ties, with additional throws as warranted by surgical circumstance and the experience of the surgeon. The use of additional throws may be particularly appropriate when knotting monofilaments.

To avoid damaging needle points and swage areas, grasp the needle in an area one-third (1/3) to one-half (1/2) of the distance from the swaged end to the point. Reshaping needles may cause them to lose strength and be less resistant to bending and breaking. Users should exercise caution when handling surgical needles to avoid inadvertent needle sticks. Discard used needles in "sharps" containers.

#### ADVERSE REACTIONS

Adverse effects associated with the use of this device include wound dehiscence, gradual loss of tensile strength over time, calculi formation in urinary and biliary tracts when prolonged contact with salt solutions such as urine and bile occurs, infection, minimal acute inflammatory tissue reaction, and transitory local irritation at the wound site. Broken needles may result in extended or additional surgeries or residual foreign bodies. Inadvertent needle sticks with contaminated surgical needles may result in the transmission of bloodborne pathogens.

#### HOW SUPPLIED

ETHILON sutures are available as sterile monofilament strands in U.S.P. sizes 11-0 through 2 (metric sizes 0.1-5.0) in a variety of lengths, with and without permanently attached needles. ETHILON sutures are available in one, two and three dozen boxes.

389355

\*Trademark

©ETHICON, INC. 1995

## FAST ABSORBING SURGICAL GUT (PLAIN)

### ABSORBABLE SURGICAL SUTURES Non-U.S.P.

#### DESCRIPTION

Fast absorbing surgical gut suture is a strand of collagenous material prepared from the submucosal layers of the small intestine of healthy sheep, or from the serosal layers of the small intestine of healthy cattle.

Fast absorbing surgical gut sutures are sterile and elicit only a slight to minimal tissue reaction during absorption.

Fast absorbing surgical gut sutures differ from U.S.P. minimum strength requirements by less than 30%.

#### INDICATIONS

Fast absorbing surgical gut sutures are intended for dermal (skin) suturing only. They should be utilized only for external knot tying procedures.

#### ACTIONS

The results of implantation studies of fast absorbing surgical gut sutures in the skin of animals indicate that nearly all of its original strength is lost within approximately seven (7) days of implantation.

When surgical gut suture is placed in tissue, a moderate tissue inflammation occurs which is characteristic of foreign body response to a substance. This is followed by a loss of tensile strength followed by a loss of suture mass, as the proteolytic enzymatic digestive process dissolves the surgical gut. This process continues until the suture is completely absorbed. Many variable factors may affect the rate of absorption. Some of the major factors which can affect tensile strength loss and absorption rates are:

1. Type of suture - plain gut generally absorbs more rapidly than chromic gut.
2. Infection - surgical gut is absorbed more rapidly in infected tissue than in non-infected tissue.
3. Tissue sites - surgical gut will absorb more rapidly in tissue where increased levels of proteolytic enzymes are present, as in the secretions exhibited in the stomach, cervix and vagina.

Data obtained from implantation studies in rats show that the absorption of these sutures is essentially complete by the twenty-first (21st) to forty-second (42nd) post implantation day.

#### CONTRAINDICATIONS

These sutures, being absorbable, should not be used where prolonged approximation of tissue under stress is required. These sutures have been designed to absorb at a rapid rate and must be used on dermal tissue only. These sutures should never be used on internal tissue. The use of this suture is contraindicated in patients with known sensitivities or allergies to collagen, as gut is a collagen based material.

#### WARNINGS

Users should be familiar with surgical procedures and techniques involving gut suture before using fast absorbing surgical gut suture for wound closure, as the risk of wound dehiscence may vary with the site of application and the suture material used. Physicians should consider the in vivo performance when selecting a suture for use in patients.

The use of this suture may be inappropriate in elderly, malnourished, or debilitated patients, or in patients suffering from conditions which may delay wound healing. As this is an absorbable material, the use of supplemental nonabsorbable sutures should be considered by the surgeon in the closure of sites which may undergo expansion, stretching or distention or which may require additional support.

As with any foreign body, prolonged contact of any suture with salt solutions, such as those found in the urinary or biliary tracts, may result in calculus formation. As an absorbable suture, fast absorbing surgical gut may act transiently as a foreign body. Acceptable surgical practice should be followed for the management of contaminated or infected wounds.

Do not resterilize. Discard open packages and unused sutures. Store at room temperature.

Certain patients may be hypersensitive to collagen and might exhibit an immunological reaction resulting in inflammation, tissue granulation or fibrosis, wound suppuration and bleeding, as well as sinus formation.

#### PRECAUTIONS

In handling this or any other suture material, care should be taken to avoid damage from handling. Avoid crushing or crimping damage due to application of surgical instruments such as forceps or needle holders. Surgical gut sutures require the accepted surgical technique of flat and square ties with additional throws as warranted by surgical circumstance and the experience of the surgeon.

Under some circumstances, notably orthopaedic procedures, immobilization of joints by external support may be employed at the discretion of the surgeon.

The surgeon should avoid unnecessary tension when running down knots, to reduce the occurrence of surface fraying and weakening of the strand.

Avoid prolonged exposure to elevated temperatures.

To avoid damaging needle points and swage areas, grasp the needle in an area one-third (1/3) to one-half (1/2) of the distance from the swaged end to the point. Reshaping needles may cause them to lose strength and be less resistant to bending and breaking. Users should exercise caution when handling surgical needles to avoid inadvertent needle sticks. Discard used needles in "sharps" containers.

#### ADVERSE REACTIONS

Adverse effects associated with the use of this device include wound dehiscence, variable rates of absorption over time (depending on such factors as the type of suture used, the presence of infection and the tissue site), failure to provide adequate wound support in closure of sites where expansion, stretching or distention occur, etc., unless additional support is supplied through the use of nonabsorbable suture material, failure to provide adequate wound support in elderly, malnourished or debilitated patients or in patients suffering from cancer, anemia, obesity, diabetes, infection or other conditions which may delay wound healing, allergic response in patients with known sensitivities to collagen which may result in an immunological reaction resulting in inflammation, tissue granulation or fibrosis, wound suppuration and bleeding, as well as sinus formation, infection, moderate tissue inflammatory response characteristic of foreign body response, calculi formation in urinary and biliary tracts when prolonged contact with salt solutions such as urine and bile occurs, and transitory local irritation at the wound site. Broken needles may result in extended or additional surgeries or residual foreign bodies. Inadvertent needle sticks with contaminated surgical needles may result in the transmission of bloodborne pathogens.

#### HOW SUPPLIED

Fast absorbing surgical gut sutures are available in sizes 5-0 (metric size 1.5) and 6-0 (metric size 1.0) with needles attached in one, two and three dozen boxes.

389359

\*Trademark

©ETHICON, INC. 1995



## MERSILENE\* POLYESTER FIBER SUTURE

NONABSORBABLE SURGICAL SUTURE, U.S.P.  
Except for size 6-0 diameter

### DESCRIPTION

MERSILENE\* polyester suture is a nonabsorbable, braided, sterile, surgical suture composed of Poly (ethylene terephthalate). It is prepared from fibers of high molecular weight, long-chain, linear polyesters having recurrent aromatic rings as an integral component. MERSILENE sutures are braided for optimal handling properties, and for good visibility in the surgical field, are dyed green.

Size 6-0 MERSILENE sutures are U.S.P., except for diameter.

#### MAXIMUM SUTURE OVERSIZE IN DIAMETER (mm) FROM U.S.P.

U.S.P. SUTURE SIZE DESIGNATION	MAXIMUM OVERSIZE (mm)
6-0	0.024

### INDICATIONS

MERSILENE suture is indicated for use in general soft tissue approximation and/or ligation, including use in cardiovascular, ophthalmic and neurological procedures.

### ACTIONS

MERSILENE suture elicits a minimal acute inflammatory reaction in tissue, followed by a gradual encapsulation of the suture by fibrous connective tissue. Implantation studies in animals show no meaningful decline in polyester suture strength over time. The polyester fiber suture material is pharmacologically inactive.

### CONTRAINDICATIONS

None known.

### WARNINGS

Users should be familiar with surgical procedures and techniques involving nonabsorbable sutures before employing MERSILENE suture for wound closure, as risk of wound dehiscence may vary with the site of application and the suture material used.

Do not resterilize. Discard opened packages and unused sutures.

As with any foreign body, prolonged contact of any suture with salt solutions, such as those found in the urinary or biliary tracts, may result in calculus formation. Acceptable surgical practice should be followed for the management of infected or contaminated wounds.

### PRECAUTIONS

In handling this or any other suture material, care should be taken to avoid damage from handling. Avoid crushing or crimping damage due to application of surgical instruments such as forceps or needle holders. The use of additional throws is particularly appropriate when knotting monofilament sutures.

As with any suture material, adequate knot security requires the accepted surgical technique of flat and square ties with additional throws as warranted by surgical circumstance and the experience of the surgeon.

To avoid damaging needle points and swage areas, grasp the needle in an area one-third (1/3) to one-half (1/2) of the distance from the swaged end to the point. Reshaping needles may cause them to lose strength and be less resistant to bending and breaking. Users should exercise caution when handling surgical needles to avoid inadvertent needle sticks. Discard used needles in "sharps" containers.

### ADVERSE REACTIONS

Adverse effects associated with the use of this device include wound dehiscence, calculi formation in urinary and biliary tracts when prolonged contact with salt solutions such as urine and bile occurs, infection, minimal acute inflammatory tissue reaction and transitory local irritation at the wound site. Broken needles may result in extended or additional surgeries or residual foreign bodies. Inadvertent needle sticks with contaminated surgical needles may result in the transmission of bloodborne pathogens.

### HOW SUPPLIED

MERSILENE sutures are available as sterile, braided, green and undyed (white) strands in sizes 6-0 through 5 (metric sizes 0.7-7) in a variety of lengths, with and without permanently attached needles.

MERSILENE sutures are also available in green monofilament in sizes 10-0 and 11-0 (metric sizes 0.2-0.1).

MERSILENE sutures, green, braided in U.S.P. size 0 (metric size 3.5) are also available attached to CONTROL RELEASE\* removable needles.

MERSILENE sutures are available in one, two and three dozen boxes.

389395 \*Trademark ©ETHICON,INC. 1996

## MERSILENE\* POLYESTER FIBER MESH

### Nonabsorbable Synthetic Surgical Mesh STERILE

#### DESCRIPTION

MERSILENE\* Polyester Fiber Mesh is constructed from polyethylene terephthalate, the same material used to make MERSILENE\* Polyester Fiber Suture, Nonabsorbable Surgical Suture, U.S.P. (ETHICON, INC.) MERSILENE Polyester Fiber Mesh affords excellent strength, durability and surgical adaptability, along with maximal porosity for necessary tissue ingrowth. The mesh is approximately 0.010 inches thick and is a highly flexible and compliant material.

MERSILENE mesh is knitted by a process which interlinks each fiber junction and which provides for elasticity in both directions. This construction permits the mesh to be cut into any desired shape or size without unraveling. The fiber junctions are not subject to the same work fatigue exhibited by more rigid metallic meshes. This bi-directional elastic property allows adaption to various stresses encountered in the body.

#### ACTIONS

MERSILENE mesh is a nonabsorbable mesh used to span and reinforce traumatic or surgical wounds to provide extended support during and following wound healing. Animal studies show that implantation of MERSILENE mesh elicits a minimum to slight inflammatory reaction, which is transient and is followed by the deposition of a thin fibrous layer of tissue which can grow through the interstices of the mesh, thus incorporating the mesh into adjacent tissue. The mesh remains soft and pliable, and normal wound healing is not noticeably impaired. The material is not absorbed nor is it subject to degradation or weakening by the action of tissue enzymes.

#### INDICATIONS

This mesh may be used for the repair of hernia and other fascial deficiencies that require the addition of a reinforcing or bridging material to obtain the desired surgical result.

#### CONTRAINDICATIONS

When this mesh is used in infants or children with future growth potential, the surgeon should be aware that this product will not stretch significantly as the patient grows.

MERSILENE polyester fiber mesh in contaminated wounds should be used with the understanding that subsequent infection may require removal of the material.

#### WARNINGS

MERSILENE mesh is provided by ETHICON, INC. as a sterile product. Unused MERSILENE Mesh which has been removed from the package may be resterilized not more than one time by a conventional steam autoclaving process at conditions of 250°F (121°C) for 20 minutes. MERSILENE mesh may also be flash autoclaved not more than one time at conditions of 270°F (132°C) for 10 minutes. Resterilization under any other conditions or by any other means is neither recommended nor endorsed by ETHICON, INC.

If this product should become stained with blood or soiled, it should not be resterilized for reuse.

#### PRECAUTIONS

A minimum of 6.5mm (1/4 inch) of mesh should extend beyond the suture line.

#### ADVERSE REACTIONS

No significant adverse clinical reactions to MERSILENE mesh have been reported. The use of nonabsorbable MERSILENE mesh in a wound that is contaminated or infected could lead to fistula formation and/or extrusion of the mesh.

#### INDICATIONS FOR USE

It is recommended that nonabsorbable sutures be placed 6.5 to 12.5mm (1/4 to 1/2 inch) apart at a distance approximately 6.5mm (1/4 inch) from edge of the mesh. Some surgeons prefer to suture and uncut section of mesh that is considerably large than the defect into position over the wound. The opposite sides are then sutured to assure proper closure under correct tension. When the margin sutures have all been placed, the extra mesh is trimmed away.

#### HOW SUPPLIED

MERSILENE mesh is available in single packets as sterile, undyed (white) sheets in two sizes. The sizes available are 6 x 11cm (2.5 x 4.5 inches) and 30 x 30cm (12 x 12 inches). Each sheet is 0.25mm (0.010 inch) thick.

389131

\*Trademark

©ETHICON, INC. 1987

## MONOCRYL\* (Poliglecaprone 25) Suture

### SYNTHETIC ABSORBABLE SUTURE, U.S.P., EXCEPT FOR DIAMETER

#### DESCRIPTION

MONOCRYL\* (poliglecaprone 25) suture is a monofilament synthetic absorbable surgical suture prepared from a copolymer of glycolide and epsilon-caprolactone. Poliglecaprone 25 copolymer has been found to be nonantigenic, nonpyrogenic and elicits only a slight tissue reaction during absorption.

MONOCRYL sutures are U.S.P. except for diameters in the following sizes:

MAXIMUM SUTURE OVERSIZE IN DIAMETER (mm) FROM U.S.P.	
U.S.P. SUTURE SIZE DESIGNATION	MAXIMUM OVERSIZE (mm)
6-0	0.049
5-0	0.033
4-0	0.045
3-0	0.067
2-0	0.055
0	0.088
1	0.066
2	0.099

#### INDICATIONS

MONOCRYL sutures are indicated for use in general soft tissue approximation and/or ligation, but not for use in cardiovascular or neurological tissues, microsurgery or ophthalmic surgery.

#### ACTIONS

MONOCRYL suture is a monofilament which elicits a minimal acute inflammatory reaction in tissues and ingrowth of fibrous connective tissue. Progressive loss of tensile strength and eventual absorption of MONOCRYL sutures occurs by means of hydrolysis. Absorption begins as a loss of tensile strength followed by a loss of mass. Implantation studies in rats indicate that MONOCRYL suture retains approximately 50 to 60% of its original strength 7 days post implantation, and approximately 20 to 30% of its original tensile strength at 14 days post implantation. All of the original tensile strength is lost by 21 days post implantation. The absolute strength remaining 14 days post implantation meets or exceeds that historically observed with plain or chromic surgical gut sutures. Absorption of MONOCRYL absorbable synthetic suture is essentially complete between 91 and 119 days.

APPROXIMATE % ORIGINAL	
DAYS IMPLANTATION	STRENGTH REMAINING
7 DAYS	50 TO 60%
14 DAYS	20 TO 30%

#### CONTRAINDICATIONS

This suture, being absorbable, should not be used where extended approximation of tissue under stress is required, such as in fascia.

#### WARNINGS

Users should be familiar with surgical procedures and techniques involving absorbable sutures before employing MONOCRYL suture for wound closure, as risk of wound dehiscence may vary with the site of application and the suture material used. Physicians should consider the *in vivo* performance (under ACTIONS section) when selecting a suture for use in patients. The use of this suture may be inappropriate in elderly, malnourished, or debilitated patients, or in patients suffering from conditions which may delay wound healing.

Do not resterilize. Discard opened packages and unused sutures.

As with any foreign body, prolonged contact of any suture with salt solutions, such as those found in the urinary or biliary tracts, may result in calculus formation. As an absorbable suture, MONOCRYL suture may act transiently as a foreign body. Acceptable surgical practice should be followed for the management of contaminated or infected wounds.

As this is an absorbable suture material, the use of supplemental nonabsorbable sutures should be considered by the surgeon in the closure of the sites which may undergo expansion, stretching or distention, or which may require additional support.

#### PRECAUTIONS

Skin sutures which must remain in place longer than 7 days may cause localized irritation and should be snipped off or removed as indicated. Subcuticular sutures should be placed as deeply as possible to minimize the erythema and induration normally associated with absorption.

Under some circumstances, notably orthopaedic procedures, immobilization of joints by external support may be employed at the discretion of the surgeon.

Consideration should be taken in the use of absorbable sutures in tissue with poor blood supply as suture extrusion and delayed absorption may occur.

In handling this or any other suture material, care should be taken to avoid damage from handling. Avoid crushing or crimping damage due to application of surgical instruments such as forceps or needle holders.

MONOCRYL suture knots must be properly placed to be secure. Adequate knot security requires the accepted surgical technique of flat and square ties with additional throws as warranted by surgical circumstance and the experience of the surgeon. The use of additional throws may be particularly appropriate when knotting monofilaments.

Avoid prolonged exposure to elevated temperature.

To avoid damaging needle points and swage areas, grasp the needle in an area one-third (1/3) to one-half (1/2) of the distance from the swaged end to the point. Reshaping needles may cause them to lose strength and be less resistant to bending and breaking. Users should exercise caution when handling surgical needles to avoid inadvertent needle sticks. Discard used needles in "sharps" containers.

#### ADVERSE REACTIONS

Adverse effects associated with the use of synthetic absorbable sutures include wound dehiscence, failure to provide adequate wound support in closure of the sites where expansion, stretching, or distension occur, failure to provide adequate wound support in elderly, malnourished or debilitated patients or in patients suffering from conditions which may delay wound healing, infection, minimal acute inflammatory tissue reaction, localized irritation when skin sutures are left in place for greater than 7 days, suture extrusion and delayed absorption in tissue with poor blood supply, calculi formation in urinary and biliary tracts when prolonged contact with salt solutions such as urine and bile occurs, and transitory local irritation at the wound site. Broken needles may result in extended or additional surgeries or residual foreign bodies. Inadvertent needle sticks with contaminated surgical needles may result in the transmission of bloodborne pathogens.

#### HOW SUPPLIED

MONOCRYL sutures are available as sterile, monofilament, undyed (natural) strands in sizes 6-0 through 2 (metric sizes 0.7-5), in a variety of lengths, with or without needles.

MONOCRYL sutures are also available in sizes 3-0 through 1 (metric sizes 2-4) attached to CONTROL RELEASE\* removable needles.

MONOCRYL sutures are available in one and three dozen boxes.

389385

\*Trademark

©ETHICON, INC. 1995

## MONOCRYL\* VIOLET MONOFILAMENT (Poliglecaprone 25) Suture

SYNTHETIC ABSORBABLE SUTURE, U.S.P.,  
EXCEPT FOR DIAMETER

### DESCRIPTION

MONOCRYL\* (poliglecaprone 25) suture is a monofilament synthetic absorbable surgical suture prepared from a copolymer of glycolide and epsilon-caprolactone. Poliglecaprone 25 copolymer has been found to be nonantigenic, nonpyrogenic and elicits only a slight tissue reaction during absorption.

MONOCRYL sutures are U.S.P. except for diameters in the following sizes:

MAXIMUM SUTURE OVERSIZE IN DIAMETER (mm) FROM U.S.P.	
U.S.P. SUTURE SIZE DESIGNATION	MAXIMUM OVERSIZE (mm)
6-0	0.049
5-0	0.033
4-0	0.045
3-0	0.067
2-0	0.055
0	0.088
1	0.066
2	0.099

### INDICATIONS

MONOCRYL sutures are indicated for use in general soft tissue approximation and/or ligation, but not for use in cardiovascular or neurological tissues, microsurgery or ophthalmic surgery.

### ACTIONS

MONOCRYL suture is a monofilament which elicits a minimal acute inflammatory reaction in tissues and ingrowth of fibrous connective tissue. Progressive loss of tensile strength and eventual absorption of MONOCRYL sutures occurs by means of hydrolysis. Absorption begins as a loss of tensile strength followed by a loss of mass. Implantation studies in rats indicate that MONOCRYL suture retains approximately 60 to 70% of its original strength 7 days post implantation, and approximately 30 to 40% of its original tensile strength at 14 days post implantation. Essentially all of the original tensile strength is lost by 28 days post implantation. Absorption of MONOCRYL absorbable synthetic suture is essentially complete between 91 and 119 days.

APPROXIMATE % ORIGINAL	
DAYS IMPLANTATION	STRENGTH REMAINING
7 DAYS	60 TO 70%
14 DAYS	30 TO 40%

### CONTRAINDICATIONS

This suture, being absorbable, should not be used where extended approximation of tissue under stress is required.

### WARNINGS

Users should be familiar with surgical procedures and techniques involving absorbable sutures before employing MONOCRYL suture for wound closure, as risk of wound dehiscence may vary with the site of application and the suture material used. Physicians should consider the in vivo performance (under ACTIONS section) when selecting a suture for use in patients. The use of this suture may be inappropriate in elderly, malnourished, or debilitated patients, or in patients suffering from conditions which may delay wound healing.

Do not resterilize. Discard opened packages and unused sutures.

As with any foreign body, prolonged contact of any suture with salt solutions, such as those found in the urinary or biliary tracts, may result in calculus formation. As an absorbable suture, MONOCRYL suture may act transiently as a foreign body. Acceptable surgical practice should be followed for the management of contaminated or infected wounds.

As this is an absorbable suture material, the use of supplemental nonabsorbable sutures should be considered by the surgeon in the closure of the sites which may undergo expansion, stretching or distention, or which may require additional support.

### PRECAUTIONS

Skin sutures which must remain in place longer than 7 days may cause localized irritation and should be snipped off or removed as indicated. Subcuticular sutures should be placed as deeply as possible to minimize the erythema and induration normally associated with absorption.

Under some circumstances, notably orthopaedic procedures, immobilization of joints by external support may be employed at the discretion of the surgeon.

Consideration should be taken in the use of absorbable sutures in tissue with poor blood supply as suture extrusion and delayed absorption may occur.

In handling this or any other suture material, care should be taken to avoid damage from handling. Avoid crushing or crimping damage due to application of surgical instruments such as forceps or needle holders.

MONOCRYL suture knots must be properly placed to be secure. Adequate knot security requires the accepted surgical technique of flat and square ties with additional throws as warranted by surgical circumstance and the experience of the surgeon. The use of additional throws may be particularly appropriate when knotting monofilaments.

Avoid prolonged exposure to elevated temperature.

To avoid damaging needle points and swage areas, grasp the needle in an area one-third (1/3) to one-half (1/2) of the distance from the swaged end to the point. Reshaping needles may cause them to lose strength and be less resistant to bending and breaking. Users should exercise caution when handling surgical needles to avoid inadvertent needle sticks. Discard used needles in "sharps" containers.

### ADVERSE REACTIONS

Adverse effects associated with the use of synthetic absorbable sutures include wound dehiscence, failure to provide adequate wound support in closure of the sites where expansion, stretching, or distension occur, failure to provide adequate wound support in elderly, malnourished or debilitated patients or in patients suffering from conditions which may delay wound healing, infection, minimal acute inflammatory tissue reaction, localized irritation when skin sutures are left in place for greater than 7 days, suture extrusion and delayed absorption in tissue with poor blood supply, calculi formation in urinary and biliary tracts when prolonged contact with salt solutions such as urine and bile occurs, and transitory local irritation at the wound site. Broken needles may result in extended or additional surgeries or residual foreign bodies. Inadvertent needle sticks with contaminated surgical needles may result in the transmission of bloodborne pathogens.

### HOW SUPPLIED

MONOCRYL sutures are available as sterile, monofilament, dyed (violet) strands in sizes 6-0 through 2 (metric sizes 0.7-5), in a variety of lengths, with or without needles. MONOCRYL sutures are also available in sizes 3-0 through 1 (metric sizes 2-4) attached to CONTROL RELEASE\* removable needles.

MONOCRYL sutures are available in one and three dozen boxes.

389310

\*Trademark

© ETHICON, INC. 1996

## **NUROLON\* NYLON SUTURE**

### **NONABSORBABLE SURGICAL SUTURE, U.S.P.**

#### **DESCRIPTION**

NUROLON\* nylon suture is a nonabsorbable sterile surgical braided suture composed of the long-chain aliphatic polymers Nylon 6 or Nylon 6,6. NUROLON sutures are dyed black to enhance visibility in tissue. The suture is also available undyed (clear).

NUROLON suture meets all requirements established by the United States Pharmacopoeia (U.S.P.) for nonabsorbable surgical suture.

#### **INDICATIONS**

NUROLON suture is indicated for use in general soft tissue approximation and/or ligation, including use in cardiovascular, ophthalmic and neurological procedures.

#### **ACTIONS**

NUROLON suture elicits a minimal acute inflammatory reaction in tissue, which is followed by a gradual encapsulation of the suture by fibrous connective tissue. While nylon is not absorbed, progressive hydrolysis of the nylon in vivo may result in gradual loss of tensile strength over time.

#### **CONTRAINDICATIONS**

Due to the gradual loss of tensile strength which may occur over prolonged periods in vivo, nylon suture should not be used where permanent retention of tensile strength is required.

#### **WARNINGS**

Users should be familiar with surgical procedures and techniques involving nonabsorbable sutures before employing NUROLON suture for wound closure, as risk of wound dehiscence may vary with the site of application and the suture material used.

As with any foreign body, prolonged contact of any suture with salt solutions, such as those found in the urinary or biliary tracts, may result in calculus formation. Acceptable surgical practices should be followed for the management of infected or contaminated wounds.

Do not resterilize. Discard opened packages and unused sutures.

#### **PRECAUTIONS**

In handling this or any other suture material, care should be taken to avoid damage from handling. Avoid crushing or crimping damage due to application of surgical instruments such as forceps or needle holders.

As with any suture material, adequate knot security requires the accepted surgical technique of flat and square ties with additional throws as warranted by surgical circumstance and the experience of the surgeon.

To avoid damaging needle points and swage areas, grasp the needle in an area one-third (1/3) to one-half (1/2) of the distance from the swaged end to the point. Reshaping needles may cause them to lose strength and be less resistant to bending and breaking. Users should exercise caution when handling surgical needles to avoid inadvertent needle sticks. Discard used needles in "sharps" containers.

#### **ADVERSE REACTIONS**

Adverse effects associated with the use of this device include wound dehiscence, gradual loss of tensile strength over time, calculi formation in urinary and biliary tracts when prolonged contact with salt solutions such as urine and bile occurs, infection, minimal acute inflammatory tissue reaction, and transitory local irritation at the wound site. Broken needles may result in extended or additional surgeries or residual foreign bodies. Inadvertent needle sticks with contaminated surgical needles may result in the transmission of bloodborne pathogens.

#### **HOW SUPPLIED**

NUROLON sutures are available in U.S.P. sizes 6-0 through 1 (metric sizes 0.7-4.0) in a variety of lengths with and without permanently attached needles.

NUROLON sutures are available in U.S.P. sizes 4-0 through 1 (metric sizes 1.5-4.0) attached to CONTROL RELEASE\* removable needles.

NUROLON sutures are available in one, two and three dozen boxes.

389354 \*Trademark ©ETHICON, INC. 1995



**PDS\* II (POLYDIOXANONE) Suture  
DYED and CLEAR MONOFILAMENT  
SYNTHETIC ABSORBABLE SUTURES, U.S.P.,  
EXCEPT FOR DIAMETER.**

**DESCRIPTION**

PDS\* II (polydioxanone) monofilament synthetic absorbable suture is prepared from the polyester, poly (p-dioxanone). The empirical molecular formula of the polymer is  $(C_4H_6O_3)_x$ .

Polydioxanone polymer has been found to be nonantigenic, nonpyrogenic and elicits only a slight tissue reaction during absorption. PDS II sutures are U.S.P., except for diameter.

**MAXIMUM SUTURE OVERSIZE IN DIAMETER (mm) FROM U.S.P.**

<u>U.S.P. SUTURE SIZE DESIGNATION</u>	<u>MAXIMUM OVERSIZE (mm)</u>
9-0	.005
8-0	.008
7-0	.020
6-0	.015
5-0	.029
4-0	.029
3-0	.056
2-0	.029
0	.071
1	.047
2	.023

**ACTIONS**

Two important characteristics describe the in vivo performance of absorbable sutures: first, tensile strength retention, and second, the absorption rate (loss of mass). PDS II synthetic absorbable suture has been formulated to minimize the variability of these characteristics and to provide wound support through an extended healing period.

The results of implantation studies of PDS II monofilament suture in animals indicate that approximately 70% of its original strength remains two weeks after implantation. At four weeks post-implantation, approximately 50% of its original strength is retained, and at six weeks, approximately 25% of the original strength is retained.

Data obtained from implantation studies in rats show that the absorption of these sutures is minimal until about the 90th post-implantation day. Absorption is essentially complete within six months.

**INDICATIONS**

PDS II monofilament synthetic absorbable sutures are indicated for use in all types of soft tissue approximation, including use in pediatric cardiovascular tissue where growth is expected to occur and ophthalmic surgery. PDS II suture is not indicated in adult cardiovascular tissue, microsurgery and neural tissue. These sutures are particularly useful where the combination of an absorbable suture and extended wound support (up to six weeks) is desirable.

**CONTRAINDICATIONS**

These sutures, being absorbable, are not to be used where prolonged (beyond six weeks) approximation of tissues under stress is required are not to be used in conjunction with prosthetic devices, i.e., heart valves or synthetic grafts.

**WARNINGS**

The safety and effectiveness of PDS II (polydioxanone) sutures have not been established in neural tissue, adult cardiovascular tissue or for use in micro-surgery.

Under certain circumstances, notably orthopaedic procedures, immobilization by external support may be employed at the discretion of the surgeon.

Do not resterilize.

**PRECAUTIONS**

The PDS II suture knots must be properly placed to be secure. As with other synthetic sutures, knot security requires the standard surgical technique of flat and square ties with additional throws if indicated by surgical circumstance and the experience of the operator.

As with any suture, care should be taken to avoid damage when handling. Avoid the crushing or crimping application of surgical instruments, such as needle holders and forceps, to the strand except when grasping the free end of the suture during an instrument tie.

Conjunctival and vaginal mucosal sutures remaining in place for extended periods may be associated with localized irritation and should be removed as indicated.

Subcuticular sutures should be placed as deeply as possible in order to minimize the erythema and induration normally associated with absorption.

Acceptable surgical practice should be followed with respect to drainage and closure of infected wounds.

**ADVERSE REACTIONS**

Due to prolonged suture absorption, some irritation and bleeding has been observed in the conjunctiva and mild irritation has been observed in the vaginal mucosa.

**DOSAGE AND ADMINISTRATION**

Use as required per surgical procedure.

**HOW SUPPLIED**

PDS II sutures are available as sterile, monofilament dyed (violet) strands in sizes 9-0 thru 2 (metric sizes 0.3-5), and sterile, monofilament dyed (blue) strands in size 9-0 thru 7-0 (metric size 0.3-0.5) in a variety of lengths, with a variety of needles.

PDS II monofilament dyed (violet) sutures, sizes 4-0 thru 1 (metric size 1.5-4) are also available attached to CONTROL RELEASE\* removable needles.

PDS II Clear suture strands are available in sizes 7-0 thru 1 (metric size 0.5-4) in a variety of lengths with permanently attached needles.

388W91      \*Trademark      ©ETHICON, INC. 1992

## PERMA-HAND\* SILK SUTURE

### NONABSORBABLE SURGICAL SUTURE, U.S.P.

#### DESCRIPTION

PERMA-HAND\* silk suture is a nonabsorbable, sterile, surgical suture composed of an organic protein called fibroin. This protein is derived from the domesticated species *Bombyx mori* (b. More) of the family Bombycidae. PERMA-HAND sutures are processed to remove the natural waxes and gums. PERMA-HAND suture is dyed black and coated with a special wax mixture. PERMA-HAND suture is also available in its natural color. PERMA-HAND Virgin silk suture is available in which the sericin gum is not removed and serves to hold the filaments together.

PERMA-HAND suture meets requirements established by the United States Pharmacopoeia (U.S.P.) for nonabsorbable surgical suture.

#### INDICATIONS

PERMA-HAND suture is indicated for use in general soft tissue approximation and/or ligation, including use in cardiovascular, ophthalmic and neurological procedures.

#### ACTIONS

PERMA-HAND suture elicits an acute inflammatory reaction in tissue, which is followed by a gradual encapsulation of the suture by fibrous connective tissue. While silk sutures are not absorbed, progressive degradation of the proteinaceous silk fiber in vivo may result in gradual loss of all of the suture's tensile strength over time.

#### CONTRAINDICATIONS

The use of this suture is contraindicated in patients with known sensitivities or allergies to silk.

Due to the gradual loss of tensile strength which may occur over prolonged periods in vivo, silk should not be used where permanent retention of tensile strength is required.

#### WARNINGS

Users should be familiar with surgical procedures and techniques involving nonabsorbable sutures before employing PERMA-HAND suture for wound closure, as risk of wound dehiscence may vary with the site of application and the suture material used.

As with any foreign body, prolonged contact of any suture with salt solutions, such as those found in the urinary or biliary tracts, may result in calculus formation. Acceptable surgical practice should be followed for the management of infected or contaminated wounds.

Do not sterilize. Discard opened packages and unused sutures.

#### PRECAUTIONS

In handling this or any other suture material, care should be taken to avoid damage from handling. Avoid crushing or crimping damage due to application of surgical instruments such as forceps or needle holders.

As with any suture material, adequate knot security requires the accepted surgical technique of flat and square ties with additional throws as warranted by surgical circumstance and the experience of the surgeon.

To avoid damaging needles points and swage areas, grasp the needle in an area one-third (1/3) to one-half (1/2) of the distance from the swaged end to the point. Reshaping needles may cause them to lose strength and be less resistant to bending and breaking. Users should exercise caution when handling surgical needles to avoid inadvertent needle sticks. Discard used needles in "sharps" containers.

#### ADVERSE REACTIONS

Adverse effects associated with the use of this device include wound dehiscence, gradual loss of all tensile strength over time, allergic response in patients that are known to be sensitive to silk, calculi formation in urinary and biliary tracts when prolonged contact with salt solutions such as urine and bile occurs, infection, acute inflammatory tissue reaction, and transitory local irritation at the wound site. Broken needles may result in extended or additional surgeries or residual foreign bodies. Inadvertent needle sticks with contaminated surgical needles may result in the transmission of bloodborne pathogens.

#### HOW SUPPLIED

PERMA-HAND sutures are available in U.S.P. sizes 9-0 through 5 (metric sizes 0.3-7.0) in a variety of lengths with and without permanently attached needles and on LIGAPAK\* dispensing reels.

PERMA-HAND sutures are also available in U.S.P. sizes 4-0 through 1 (metric sizes 1.5-4.0) attached to CONTROL RELEASE\* removable needles.

PERMA-HAND sutures are available in one, two, and three dozen boxes.

389353

\*Trademark

©ETHICON, INC. 1995

**PROLENE\* POLYPROPYLENE SUTURE****NONABSORBABLE SURGICAL SUTURE, U.S.P.**

Except for size 7-0 diameter  
and HEMO-SEAL\* Needle Suture Attachment

**DESCRIPTION**

PROLENE\* polypropylene suture (clear or pigmented) is a nonabsorbable, sterile surgical suture composed of an isotactic crystalline stereoisomer of polypropylene, a synthetic linear polyolefin. The suture is pigmented blue to enhance visibility.

Size 7-0 PROLENE sutures are U.S.P., except for diameter.

MAXIMUM SUTURE OVERSIZE IN DIAMETER (mm) FROM U.S.P.	
U.S.P. SUTURE SIZE DESIGNATION	MAXIMUM OVERSIZE (mm)
7-0	.007

PROLENE suture, available as HEMO-SEAL\* needle suture, is a needle suture combination in which the diameter of the needle swage area has been reduced to facilitate attachment of finer wire diameter needles. The diameter of the suture strand and the needle wire have been more closely aligned to reduce the degree of needle hole bleeding. HEMO-SEAL needle suture differs from U.S.P. in needle attachment requirements only.

**INDICATIONS**

PROLENE suture is indicated for use in general soft tissue approximation and/or ligation, including use in cardiovascular, ophthalmic and neurological procedures.

**ACTIONS**

PROLENE suture elicits a minimal acute inflammatory reaction in tissue, which is followed by gradual encapsulation of the suture by fibrous connective tissue. PROLENE suture is not absorbed, nor is it subject to degradation or weakening by the action of tissue enzymes. As a monofilament, PROLENE suture, U.S.P. resists involvement in infection and has been successfully employed in contaminated and infected wounds to eliminate or minimize later sinus formation and suture extrusion. The lack of adherence to tissues has facilitated the use of PROLENE suture as a pull-out suture.

**CONTRAINDICATIONS**

None known.

**WARNINGS**

Users should be familiar with surgical procedures and techniques involving nonabsorbable sutures before employing PROLENE suture for wound closure, as risk of wound dehiscence may vary with the site of application and the suture material used.

Do not resterilize. Discard opened packages and unused sutures.

As with any foreign body, prolonged contact of any suture with salt solutions, such as those found in the urinary or biliary tracts, may result in calculus formation. Acceptable surgical practice must be followed for the management of infected or contaminated wounds.

**PRECAUTIONS**

In handling this suture material, care should be taken to avoid damage from handling. Avoid crushing or crimping damage due to application of surgical instruments such as forceps or needle holders.

Adequate knot security requires the accepted surgical technique of flat, square ties of single suture strands. The use of additional throws is particularly appropriate when knotting polypropylene sutures.

To avoid damaging needle points and swage areas, grasp the needle in an area one-third (1/3) to one-half (1/2) of the distance from the swaged end to the point. Reshaping needles may cause them to lose strength and be less resistant to bending and breaking. Users should exercise caution when handling surgical needles to avoid inadvertent needle sticks. Discard used needles in "sharps" containers.

**ADVERSE REACTIONS**

Adverse effects associated with the use of this device include wound dehiscence, calculi formation in urinary and biliary tracts when prolonged contact with salt solutions such as urine and bile occurs, infection, minimal acute inflammatory tissue reaction, and transitory local irritation at the wound site. Broken needles may result in extended or additional surgeries or residual foreign bodies. Inadvertent needle sticks with contaminated surgical needles may result in the transmission of bloodborne pathogens.

**HOW SUPPLIED**

PROLENE sutures, pigmented, are available as sterile strands in U.S.P. sizes 10-0 through 8-0 (metric sizes 0.2-0.4) and 6-0 through 2 (metric sizes 0.7-5.0).

PROLENE sutures, clear, are available as sterile strands in U.S.P. sizes 6-0 through 2 (metric sizes 0.7-5.0). Size 7-0 (metric size 0.5) PROLENE sutures, pigmented and clear are U.S.P. except for diameter. All PROLENE sutures are available in a variety of lengths, with permanently attached needles.

PROLENE sutures, pigmented and clear are also available as sterile strands in U.S.P. sizes 0 through 2 (metric sizes 3.5-5.0) attached to CONTROL RELEASE\* removable needles.

PROLENE sutures, pigmented and clear are also available as sterile strands in U.S.P. sizes 0 through 5-0, attached to TFE pledgets measuring 1/4" x 1/8" x 1/16" (7.0mm x 3.0mm x 1.5mm).

PROLENE sutures, pigmented and clear are also available in sterile strands as HEMO-SEAL\* needle sutures in the following sizes:

PROLENE Suture U.S.P. Size	HEMO-SEAL Needle Suture	HEMO-SEAL Needle Suture Limits on Needle Attachment	
		Avg. (Kgf) Min.	Individual (Kgf) Min.
5-0	HS-7	0.17	0.08
4-0	HS-6	0.23	0.11
3-0	HS-5	0.45	0.23

USP Limits on Needle Attachment			
U.S.P. Size	Avg. (Kgf)		Individual (Kgf)
	Min.	Max.	Min.
5-0	0.23	0.45	0.11
4-0	0.45	0.68	0.23
3-0	0.68	1.00	0.34

PROLENE sutures are available in one, two, and three dozen boxes.

389361

\*Trademark

©ETHICON, INC. 1995

## PROLENE\* (POLYPROPYLENE) HERNIA SYSTEM

### Nonabsorbable Synthetic Surgical Mesh

#### DESCRIPTION

The PROLENE\* (Polypropylene) Hernia System is a sterile, pre-shaped, three dimensional device constructed of an onlay patch connected by a mesh cylinder to a circular underlay patch. The material is undyed PROLENE\* (Polypropylene) MESH constructed of knitted nonabsorbable polypropylene filaments.

#### ACTIONS/PERFORMANCE

The PROLENE Hernia System is a nonabsorbable mesh used to reinforce or bridge inguinal hernia deficiencies to provide extended support during and following wound healing. Animal studies show that implantation of PROLENE Mesh elicits a minimum to slight inflammatory reaction, which is transient and is followed by the deposition of a thin fibrous layer of tissue which can grow through the interstices of the mesh, thus incorporating the mesh into adjacent tissue. The mesh remains soft and pliable, and normal wound healing is not noticeably impaired. The material is neither absorbed nor is it subject to degradation or weakening by the action of tissue enzymes.

#### INDICATIONS

This product is indicated for the repair of indirect and direct inguinal hernia defects.

#### WARNINGS

The PROLENE Hernia System is provided by ETHICON, INC. as a sterile product. This device is for single use only. Do not resterilize. Discard opened packages and unused product.

When this device is used in infants or children with future growth potential, the surgeon should be aware that this product will not stretch significantly as the patient grows.

The PROLENE Hernia System should only be used in contaminated wounds with the understanding that subsequent infection may require removal of the device.

#### PRECAUTIONS

Sutures or clips, if necessary, should be placed such that a minimum of 6.5 mm (1/4") of mesh should extend beyond the suture line.

#### ADVERSE REACTIONS

Potential adverse reactions are those typically associated with surgically implantable materials which include infection potentiation, inflammation, adhesion formation, fistula formation and extrusion.

#### INSTRUCTIONS FOR USE

For indirect hernia, a high dissection of the neck of the hernia sac to utilize the potential of the preperitoneal space can be performed to insert the PROLENE Hernia System. The circular or bottom underlay portion of the PROLENE Hernia System is folded and is inserted through the internal ring allowing the mesh to expand to the underlay position. Surgical manipulation may be used to facilitate the expansion of the device to the underlay position. No sutures are necessary in the bottom underlay patch. The top onlay patch, which is designed to cover the posterior wall (floor of the canal), is then modified as needed to accommodate the cord structures. If one end of the oval onlay patch is longer than the other, the PROLENE Hernia System is positioned so that the longer end covers the posterior wall (floor of the canal) and overlaps the pubic tubercle.

For direct hernia, the defect is circumscribed at its base, the contents fully reduced, and the preperitoneal space is actualized prior to the insertion of the PROLENE Hernia System. The circular or bottom underlay portion of the PROLENE Hernia System is folded and is inserted through the defect or the internal ring allowing the mesh to expand to the underlay position. The underlay portion should expand under the defect in the floor of the canal. Surgical manipulation may be used to facilitate the expansion of the device to the underlay position. Sutures or clips may be used to secure the top onlay patch in place.

#### STERILITY

The PROLENE Hernia System is sterilized by Ethylene Oxide. Do not resterilize. Do not use if package is opened or damaged. Discard open, unused product.

#### STORAGE

Recommended storage conditions: below 25°C, 77°F, away from moisture and direct heat. Do not use after expiry date.

#### HOW SUPPLIED

The PROLENE Hernia System is available sterile, undyed in several sizes.

#### CAUTION

Federal (U.S.A.) Law restricts this device to sale by or on the order of a physician.

\* Trademark

©ETHICON, INC. 1997

## PROLENE\* POLYPROPYLENE MESH

### NONABSORBABLE SYNTHETIC SURGICAL MESH

### STERILE

#### DESCRIPTION

PROLENE\* polypropylene mesh is constructed of knitted filaments of extruded polypropylene identical in composition to that used in PROLENE\* Polypropylene Suture, Nonabsorbable Surgical Sutures, U.S.P. (ETHICON, INC.). The mesh is approximately 0.020 inches thick. This material, when used as a suture, has been reported to be non-reactive and to retain its strength indefinitely in clinical use.

PROLENE mesh is knitted by a process which interlinks each fiber junction and which provides for elasticity in both directions. This construction permits the mesh to be cut into any desired shape or size without unraveling. The fiber junctions are not subject to the same work fatigue exhibited by more rigid metallic meshes. This bi-directional elastic property allows adaption to various stresses encountered in the body.

#### ACTIONS

PROLENE mesh is a nonabsorbable mesh used to span and reinforce traumatic or surgical wounds to provide extended support during and following wound healing. Animal studies show that implantation of PROLENE mesh elicits a minimum to slight inflammatory reaction, which is transient and is followed by the deposition of a thin fibrous layer of tissue which can grow through the interstices of the mesh, thus incorporating the mesh into adjacent tissue. The mesh remains soft and pliable, and normal wound healing is not noticeably impaired. The material is not absorbed nor is it subject to degradation or weakening by the action of tissue enzymes.

#### INDICATIONS

This mesh may be used for the repair of hernia and other fascial deficiencies that require the addition of a reinforcing or bridging material to obtain the desired surgical result.

#### CONTRAINDICATIONS

When this mesh is used in infants or children with future growth potential, the surgeon should be aware that this product will not stretch significantly as the patient grows.

PROLENE mesh in contaminated wounds should be used with the understanding that subsequent infection may require removal of the material.

#### WARNINGS

PROLENE mesh is provided by ETHICON, INC. as a sterile product. Resterilization of the device is NOT recommended. However, testing has demonstrated that reprocessing of unused PROLENE mesh which has been removed from the package will not be adversely affected when exposed not more than one time to conventional steam autoclave conditions of 250° F (121° C) for 20 minutes. Reprocessing under any other condition or by any other means is neither recommended nor endorsed by ETHICON, INC. PROLENE mesh should not be flash autoclaved.

If this product should become stained with blood or soiled, it should not be resterilized for reuse.

When reprocessed as outlined above, it is the responsibility of the end-user to assure sterility of the product via a validated sterilization process as ETHICON, INC. has no control over environmental conditions the product may encounter prior to - during - or after reprocessing.

#### PRECAUTIONS

A minimum of 6.5mm (1/4") of mesh should extend beyond the suture line.

#### ADVERSE REACTIONS

Potential adverse reactions are those typically associated with surgically implantable materials which include infection potentiation, inflammation, adhesion formation, fistula formation and extrusion.

#### INSTRUCTIONS FOR USE

It is recommended that nonabsorbable sutures be placed 6.5mm to 12.5mm (1/4" to 1/2") apart at a distance approximately 6.5mm (1/4") from edge of the mesh. Some surgeons prefer to suture an uncut section of mesh that is considerably larger than the defect into position over the wound. The opposite sides are then sutured to assure proper closure under correct tension. When the margin sutures have all been placed, the extra mesh is trimmed away.

#### HOW SUPPLIED

PROLENE mesh is available in single packets as sterile, undyed (clear) sheets in seven sizes. The sizes available are 2.5cm x 10cm (1" x 4"), 4.6cm x 10.2cm (1.8" x 4"), 6cm x 11cm (2.5" x 4.5"), 6.1cm x 13.7cm (2.4" x 5.4"), 7.6cm x 12.7cm (3" x 5"), 15cm x 15cm (6" x 6") and 30cm x 30cm (12" x 12"). Each sheet is approximately 0.5mm (0.020") thick.

389392.R01

\*Trademark

©ETHICON, INC. 1996



## PRONOVA\* POLY (HEXAFLUOROPROPY- LENE-VDF) SUTURE

NONABSORBABLE SURGICAL SUTURE, U.S.P.  
EXCEPT FOR SIZE 7-0 DIAMETER

### DESCRIPTION

PRONOVA\* suture (clear or pigmented) is a nonabsorbable, sterile surgical suture made from a polymer blend of poly(vinylidene fluoride) and poly(vinylidene fluoride-co-hexafluoropropylene). The suture is pigmented blue to enhance visibility.

Size 7-0 PRONOVA sutures are U.S.P., except for diameter.

MAXIMUM SUTURE OVERSIZE IN DIAMETER (mm) FROM U.S.P.	
U.S.P. SUTURE SIZE DESIGNATION	MAXIMUM OVERSIZE (mm)
7-0	.007

### INDICATIONS

PRONOVA suture is indicated for use in general soft tissue approximation and/or ligation, including use in cardiovascular, ophthalmic and neurological procedures.

### ACTIONS

PRONOVA suture elicits a minimal to mild inflammatory reaction in tissue, which is followed by gradual encapsulation of the suture by fibrous connective tissue. PRONOVA suture is not absorbed, nor is it subject to degradation or weakening by the action of tissue enzymes. As a monofilament, PRONOVA suture, U.S.P. resists involvement in infection and has been successfully employed in contaminated and infected wounds to eliminate or minimize later sinus formation and suture extrusion. Furthermore, the lack of adherence to tissues has facilitated the use of PRONOVA suture as a pull-out suture.

### CONTRAINDICATIONS

None known.

### WARNINGS

Users should be familiar with surgical procedures and techniques involving nonabsorbable sutures before employing PRONOVA suture for wound closure, as risk of wound dehiscence may vary with the site of application and the suture material used.

Do not resterilize. Discard opened packages and unused sutures.

As with any foreign body, prolonged contact of any suture with salt solutions, such as those found in the urinary or biliary tracts, may result in calculus formation. Acceptable surgical practice must be followed for the management of infected or contaminated wounds.

### PRECAUTIONS

In handling this suture material, care should be taken to avoid damage from handling. Avoid crushing or crimping damage due to application of surgical instruments such as forceps or needle holders.

Adequate knot security requires the accepted surgical technique of flat, square ties of single suture strands. The use of additional throws is particularly appropriate when knotting monofilament sutures.

To avoid damaging needle points and swage areas, grasp the needle in an area one-third (1/3) to one-half (1/2) of the distance from the swaged end to the point. Reshaping needles may cause them to lose strength and be less resistant to bending and breaking. Users should exercise caution when handling surgical needles to avoid inadvertent needle sticks. Discard used needles in "sharps" containers.

### ADVERSE REACTIONS

Adverse effects associated with the use of this device include wound dehiscence, calculi formation in urinary and biliary tracts when prolonged contact with salt solutions such as urine and bile occurs, infection, minimal to mild inflammatory tissue reaction, and transitory local irritation at the wound site. Broken needles may result in extended or additional surgeries or residual foreign bodies. Inadvertent needle sticks with contaminated surgical needles may result in the transmission of bloodborne pathogens.

### HOW SUPPLIED

PRONOVA sutures, pigmented, are available as sterile strands in U.S.P. sizes 10-0 through 8-0 (metric sizes 0.2-0.4) and 6-0 through 2 (metric sizes 0.7-5.0).

PRONOVA sutures, clear, are available as sterile strands in U.S.P. sizes 6-0 through 2 (metric sizes 0.7-5.0). Size 7-0 (metric size 0.5) PRONOVA sutures, pigmented and clear are U.S.P. except for diameter. All PRONOVA sutures are available in a variety of lengths, with permanently attached needles.

PRONOVA sutures, pigmented and clear are also available as sterile strands in U.S.P. sizes 0 through 2 (metric sizes 3.5-5.0) attached to CONTROL RELEASE\* removable needles.

PRONOVA sutures are available in one, two, and three dozen boxes.

389556

\*Trademark

©ETHICON, INC. 1998

## PROXIMATE® SKIN STAPLER

### INDICATIONS

The Skin Stapler has application for routine skin closure in a wide variety of surgical procedures.

### CONTRAINDICATIONS

When it is not possible to maintain at least a 5 mm distance from the stapled skin to underlying bones, vessels, or internal organs, the use of staples for skin closure is contraindicated.

### DEVICE DESCRIPTION

The Skin Stapler is a sterile, single patient use instrument designed to deliver rectangular, stainless steel staples for routine wound closure.

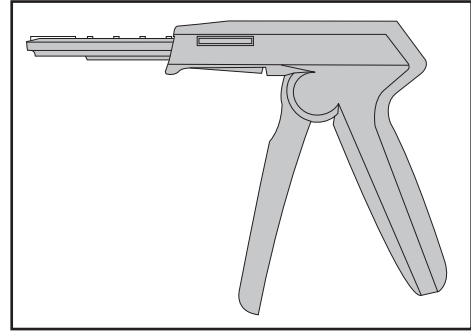

### INSTRUCTIONS FOR USE

Verify compatibility of all instruments and accessories prior to using the instrument.

- Using sterile technique, remove the instrument from the package. To avoid damage, do not flip the instrument into the sterile field.
- Suggested Eversion Techniques: With two tissue forceps, pick up each wound edge individually and approximate the edges (Illustration 1). Or, with one tissue forceps, pull skin edges together until edges evert (Illustration 2). Or, apply tension to either end of the incision, such that the tissue edges begin to approximate themselves. One forceps can be used to ensure that the edges are everted (Illustration 3).
- Position the instrument with moderate pressure over the everted skin edges. The instrument should be held at a 60° angle to the skin (Illustration 4).
- Squeeze the trigger until the trigger motion is halted, then release the trigger and move the instrument off the incision in any direction (Illustration 5).  
Alternate Release: If desired, before releasing the trigger lift up on the instrument. This will help to evert the skin edges, which can then be more easily grasped with the tissue forceps. Release the trigger after the forceps are in place, and repeat the sequence to fire the next staple. (Illustration 6)  
Alternate Technique: The instrument can also be precocked (partially fired) so that the staple points are visible at the nose of the instrument. This feature, in conjunction with the clear nose and alignment arrow, ensures precise staple placement in the skin (Illustration 7).  
Note: If desired, after the instrument has been precocked, one leg of the staple can be hooked onto one side of the tissue. This will aid in drawing the tissue together. This technique may be suitable for attaching skin grafts under moderate tension (Illustration 8).

### WARNINGS AND PRECAUTIONS

- Dispose of all opened products whether used or unused. Do Not Resterilize the instrument. Resterilization may compromise the integrity of the instrument which may result in unintended injury.

### HOW SUPPLIED

The PROXIMATE Skin Stapler is supplied sterile and preloaded for single patient use. Discard after use.

### FORMED STAPLE DIMENSIONS

Regular staples have an approximate diameter of 0.53 mm, span of 5.7 mm, and leg length of 3.9 mm.

Wide staples have an approximate diameter of 0.58 mm, span of 6.9 mm, and leg length of 3.9 mm.

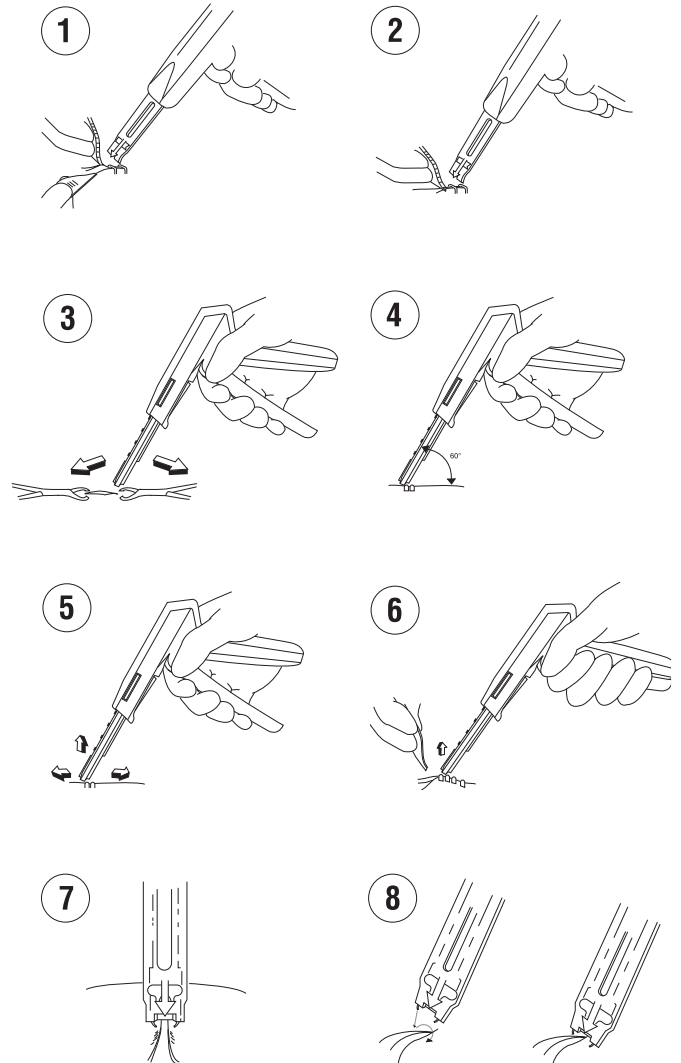

## PROXIMATE®

### SKIN STAPLER EXTRACTOR

#### INDICATIONS

The PROXIMATE Skin Staple Extractor has application for routine skin closure in a wide variety of surgical procedures.

#### CONTRAINDICATIONS

When it is not possible to maintain at least a 5 mm distance from the stapled skin to underlying bones, vessels, or internal organs, the use of staples for skin closure is contraindicated.

#### DEVICE DESCRIPTION

The PROXIMATE Skin Staple Extractor is a sterile, single patient use, stainless steel device specifically designed to completely open skin staples for removal. The function of the Skin Staple Extractor is to remove Proximate Regular or Wide Skin Staples from skin wounds.

#### Illustration and Nomenclature

1. Safety Cap
2. Jaws
3. Upper Handle
4. Lower Handle

#### INSTRUCTIONS FOR USE

Verify compatibility of all instruments and accessories prior to using the device.

- 1 Using sterile technique, remove the device from the package. To avoid damage, do not flip the device into the sterile field.
- 2 Remove the safety cap from the device.
- 3 Slide lower jaw of extractor under regular or wide staple until staple is secured in slot in lower jaw. (Illustration 1)
- 4 Squeeze down with thumb to open staple until handles are firmly touching. (Illustration 2)
- 5 Ensure staple is completely opened before lifting extractor from skin. Never pull up before extractor is fully closed. (Illustration 3)

#### Warnings and Precautions

- Dispose of all opened products whether used or unused. Do Not Resterilize the device. Resterilization may compromise the integrity of the device which may result in unintended injury.
- Instruments or devices which come into contact with bodily fluids may require special disposal handling to prevent biological contamination.

#### HOW SUPPLIED

The PROXIMATE Skin Staple Extractor is supplied sterile for single patient use. Discard after use.

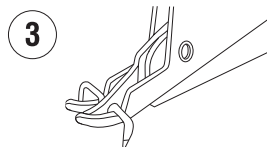
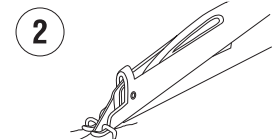
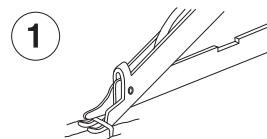
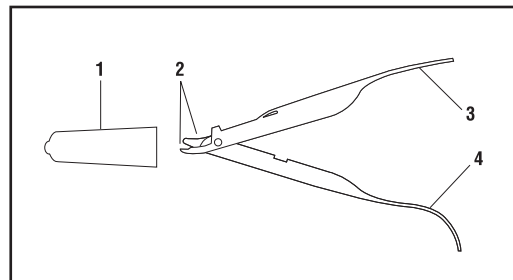
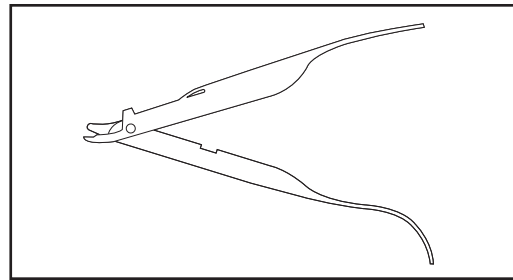

## PROXIMATE® PLUS MD

### MULTI-DIMENSIONAL RELEASE SKIN STAPLER

#### INDICATIONS

The PROXIMATE PLUS MD Skin Stapler has application for routine skin closure in a wide variety of surgical procedures.

#### CONTRAINDICATIONS

When it is not possible to maintain at least a 5 mm distance from the stapled skin to underlying bones, vessels, or internal organs, the use of staples for skin closure is contraindicated.

#### DEVICE DESCRIPTION

The PROXIMATE PLUS MD Skin Stapler is a sterile, single patient use instrument designed to deliver rectangular, stainless steel staples for routine wound closure.

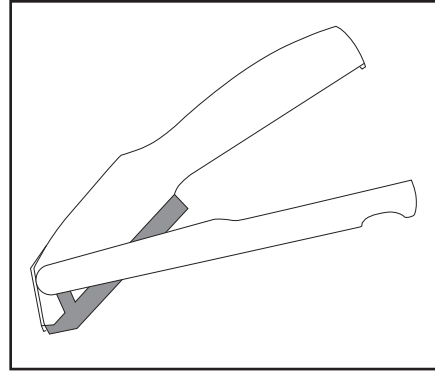

#### INSTRUCTIONS FOR USE

Verify compatibility of all instruments and accessories prior to using the instrument (refer to Warnings and Precautions).

- Using sterile technique, remove the instrument from the package. To avoid damage, do not flip the instrument into the sterile field.
- Evert and approximate skin edges as desired. Several techniques are suggested:
  - With one tissue forcep, pull skin edges together until edges evert. (Illustration 1)
  - OR
  - With two tissue forceps, pick up each wound edge individually and approximate the edges. (Illustration 2)
  - OR
  - Apply tension to either end of the incision, such that the tissue edges begin to approximate themselves. One forcep can be used to ensure that the edges are everted.
- Position the instrument over the everted skin edges, aligning the instrument arrow with the incision. (Illustration 3)
- Squeeze the trigger until the trigger motion is halted. Release the trigger and remove the instrument from the fired staple. (Illustration 4)

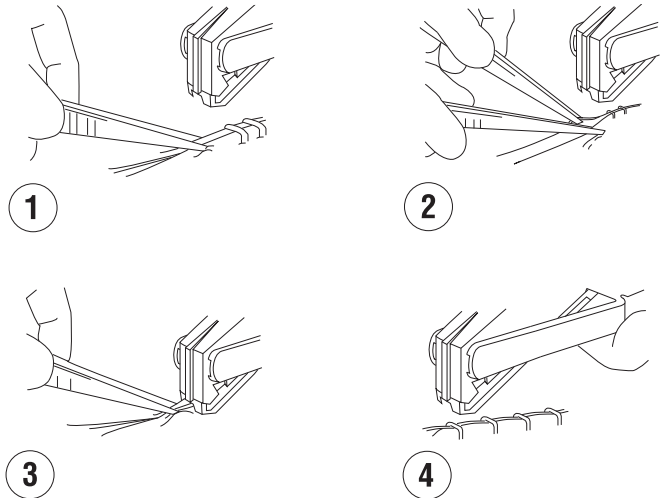

#### WARNINGS AND PRECAUTIONS

- Dispose of all opened instruments, whether used or unused. Do Not Resterilize the instrument. Resterilization may compromise the integrity of the stapler which may result in unintended injury.

#### HOW SUPPLIED

The PROXIMATE PLUS MD Skin Stapler is supplied sterile and preloaded for single patient use. Discard after use.

#### FORMED STAPLE DIMENSIONS

Regular staples have a diameter of 0.53 mm, a span of 5.7 mm, and a leg length of 3.9 mm.

Wide staples have a diameter of 0.58 mm, a span of 6.9 mm, and a leg length of 3.9 mm.

**Caution: Federal (USA) law restricts this device to sale by or on the order of a physician.**

## SURGICAL GUT SUTURE

### ABSORBABLE SURGICAL SUTURES, U.S.P.

#### DESCRIPTION

Surgical gut suture is an absorbable, sterile surgical suture composed of purified connective tissue (mostly collagen) derived from either the serosal layer of beef (bovine) or the submucosal fibrous layer of sheep (ovine) intestines. Surgical gut sutures are available in plain or chromic. Chromic gut is processed to provide greater resistance to absorption. Surgical gut is packaged in tubing fluid. Blue dyed chromic gut suture is also available.

Surgical gut suture meets all requirements established by the United States Pharmacopoeia (U.S.P.) for absorbable surgical sutures.

#### INDICATIONS

Surgical gut suture is indicated for use in general soft tissue approximation and/or ligation, including use in ophthalmic procedures, but not for use in cardiovascular and neurological tissues.

#### ACTIONS

When surgical gut suture is placed in tissue, a moderate tissue inflammation occurs which is characteristic of foreign body response to a substance. This is followed by a loss of tensile strength and a loss of suture mass, as the proteolytic enzymatic digestive process dissolves the surgical gut. This process continues until the suture is completely absorbed. Many variable factors may affect the rate of absorption. Some of the major factors which can affect tensile strength loss and absorption rates are:

1. Type of suture - plain gut generally absorbs more rapidly than chromic gut.
2. Infection - surgical gut is absorbed more rapidly in infected tissue than in non-infected tissue.
3. Tissue sites - surgical gut will absorb more rapidly in tissue where increased levels of proteolytic enzymes are present, as in the secretions exhibited in the stomach, cervix and vagina.

#### CONTRAINDICATIONS

This suture, being absorbable, should not be used where extended approximation of tissue is required.

The use of this suture is contraindicated in patients with known sensitivities or allergies to collagen or chromium, as gut is a collagen based material, and chromic gut is treated with chromic salt solutions.

#### WARNINGS

Users should be familiar with surgical procedures and techniques involving gut suture before using surgical gut suture for wound closure, as the risk of wound dehiscence may vary with the site of application and the suture material used. Physicians should consider the *in vivo* performance when selecting a suture. The use of this suture may be inappropriate in elderly, malnourished, or debilitated patients, or in patients suffering from conditions which may delay wound healing. As this is an absorbable material, the use of supplemental nonabsorbable sutures should be considered by the surgeon in the closure of sites which may undergo expansion, stretching or distention or which may require additional support.

As with any foreign body, prolonged contact of any suture with salt solutions, such as those found in the urinary or biliary tracts, may result in calculus formation. As an absorbable suture, surgical gut may act transiently as a foreign body. Acceptable surgical practice should be followed for the management of contaminated or infected wounds.

Do not resterilize. Discard open packages and unused sutures.

Certain patients may be hypersensitive to collagen or chromium and might exhibit an immunological reaction resulting in inflammation, tissue granulation or fibrosis, wound suppuration and bleeding, as well as sinus formation.

#### PRECAUTIONS

In handling this or any other suture material, care should be taken to avoid damage from handling. Avoid crushing or crimping damage due to application of surgical instruments such as forceps or needle holders. Surgical gut sutures require the accepted surgical technique of flat and square ties with additional throws as warranted by surgical circumstance and the experience of the surgeon.

Under some circumstances, notably orthopaedic procedures, immobilization of joints by external support may be employed at the discretion of the surgeon.

The surgeon should avoid unnecessary tension when running down knots, to reduce the occurrence of surface fraying and weakening of the strand.

Avoid prolonged exposure to elevated temperatures.

To avoid damaging needle points and swage areas, grasp the needle in an area one-third (1/3) to one-half (1/2) of the distance from the swaged end to the point. Reshaping needles may cause them to lose strength and be less resistant to bending and breaking. Users should exercise caution when handling surgical needles to avoid inadvertent needle sticks. Discard used needles in "sharps" containers.

#### ADVERSE REACTIONS

Adverse effects associated with the use of this device include wound dehiscence, variable rates of absorption over time (depending on such factors as the type of suture used, the presence of infection and the tissue site), failure to provide adequate wound support in closure of sites where expansion, stretching or distension occur, etc., unless additional support is supplied through the use of nonabsorbable suture material, failure to provide adequate wound support in elderly, malnourished or debilitated patients or in patients suffering from cancer, anemia, obesity, diabetes, infection or other conditions which may delay wound healing, allergic response in patients with known sensitivities to collagen or chromium which may result in an immunological reaction resulting in inflammation, tissue granulation or fibrosis, wound suppuration and bleeding, as well as sinus formation, infection, moderate tissue inflammatory response characteristic of foreign body response, calculi formation in urinary and biliary tracts when prolonged contact with salt solutions such as urine and bile occurs, and transitory local irritation at the wound site. Broken needles may result in extended or additional surgeries or residual foreign bodies. Inadvertent needle sticks with contaminated surgical needles may result in the transmission of bloodborne pathogens.

#### HOW SUPPLIED

Surgical gut sutures are available in U.S.P. sizes 7-0 through 3 (metric sizes 0.7-7.0) in a variety of lengths with and without permanently attached needles and on LIGAPAK\* dispensing reels. Surgical gut sutures are also available in U.S.P. sizes 0 through 1 (metric sizes 4.0-5.0) attached to CONTROL RELEASE\* removable needles. The suture is supplied sterile in one, two and three dozen boxes.

389360

\*Trademark

©ETHICON, INC. 1995



## **SURGICAL STAINLESS STEEL SUTURE**

### **NONABSORBABLE SURGICAL SUTURES, U.S.P.**

#### **DESCRIPTION**

Surgical stainless steel suture is a nonabsorbable, sterile surgical suture composed of 316L stainless steel. Surgical stainless steel suture is available as a monofilament and multifilament suture.

Surgical stainless steel suture meets all requirements established by the United States Pharmacopoeia (U.S.P.) for nonabsorbable surgical sutures. Surgical stainless steel suture is also labeled with the B&S gauge classifications.

#### **INDICATIONS**

Surgical stainless steel suture is indicated for use in abdominal wound closure, hernia repair, sternal closure and orthopaedic procedures including cerclage and tendon repair.

#### **ACTIONS**

Surgical stainless steel suture elicits a minimal acute inflammatory reaction in tissue and is not absorbed.

#### **CONTRAINDICATIONS**

The use of this suture is contraindicated in patients with known sensitivities or allergies to 316L stainless steel, or constituent metals such as chromium and nickel.

#### **WARNINGS**

Users should be familiar with surgical procedures and techniques involving nonabsorbable, stainless steel sutures before employing for wound closure, as the risk of wound dehiscence may vary with the site of application and the suture material used.

Acceptable surgical practice must be followed for the management of contaminated or infected wounds.

#### **PRECAUTIONS**

In handling this or any other suture material, care should be taken to avoid damage from handling, such as kinking or excessive twisting.

To avoid damaging needle points and swage areas, grasp the needle in an area one-third (1/3) to one-half (1/2) of the distance from the swaged end to the point. Reshaping needles may cause them to lose strength and be less resistant to bending and breaking. Users should exercise caution when handling surgical needles to avoid inadvertent needle sticks. Discard used needles in "sharps" containers.

#### **ADVERSE REACTIONS**

Adverse effects associated with the use of this device include wound dehiscence, allergic response in patients with known sensitivities to 316L stainless steel, or constituent metals such as chromium and nickel, infection, minimal acute inflammatory tissue reaction, pain, edema and local irritation at the wound site. Broken needles may result in extended or additional surgeries or residual foreign bodies. Inadvertent needle sticks with contaminated surgical needles may result in the transmission of bloodborne pathogens.

#### **HOW SUPPLIED**

Surgical stainless steel sutures are available in sizes 7 through 10-0 (metric sizes 9.0-0.2) in a variety of lengths with and without permanently attached needles in one, two and three dozen boxes.

389357

\*Trademark

©ETHICON, INC. 1995

## VICRYL\* Knitted Mesh

### DESCRIPTION

VICRYL\* (polyglactin 910) knitted mesh is prepared from a synthetic absorbable copolymer of glycolide and lactide, derived respectively from glycolic and lactic acids. This knitted mesh is prepared from uncoated, undyed fiber identical in composition to that used in VICRYL (polyglactin 910) synthetic absorbable suture, which has been found to be inert, nonantigenic, nonpyrogenic and to elicit only a mild tissue reaction during absorption.

VICRYL knitted mesh is intended for use as a buttress to provide temporary support during the healing process.

### ACTIONS

Two important characteristics describe the in vivo function and behavior of VICRYL knitted mesh: reinforced wound strength and the rate of absorption (loss of mass).

The dehiscence force of healing abdominal wounds in rats closed with size 4-0 absorbable sutures was compared with corresponding wounds closed with size 4-0 absorbable sutures and reinforced with VICRYL knitted mesh. In this animal model, the strength of the incision, when supported by the mesh, was significantly greater than the sutured incisional wound. Explanted VICRYL knitted mesh, which, before implantation had an initial average burst strength of 63 lbs., was found to have 80% of its original burst strength remaining after fourteen days in vivo.

Subcutaneous implantation studies in rats indicate that the absorption of VICRYL mesh material is minimal until about six weeks post implantation and essentially complete between 60 and 90 days.

### INDICATIONS

VICRYL knitted mesh may be used wherever temporary wound or organ support is required, particularly in instances in which compliant and stretchable support material is desired and containment of wound transudate is not required. VICRYL knitted mesh may be cut to the shape or size desired for each specific application.

### CONTRAINDICATIONS

Because VICRYL knitted mesh is absorbable, it should not be used where extended wound or organ support is required.

### WARNINGS

DO NOT RESTERILIZE.

The safety and effectiveness of VICRYL knitted mesh in neural tissue and in cardiovascular tissue has not been established.

### PRECAUTIONS

None.

### ADVERSE REACTIONS

No significant clinical adverse reactions to the mesh have been reported.

### DIRECTIONS FOR USE

It is recommended that absorbable or nonabsorbable sutures be placed 1/4 to 1/2 inch (6 to 12mm) apart at a distance approximately 1/4 inch (6mm) from the edge of the mesh. Some surgeons prefer to suture a mesh larger than the defect into position over the defect. The edges are then sutured to assure a proper closure under correct tension. When all margin sutures have been placed, the excess mesh is trimmed away, leaving at least 1/4 inch of mesh extending beyond the suture line.

### HOW SUPPLIED

VICRYL knitted mesh is available in single packets as a sterile, undyed fabric mesh in single sheet sizes of approximately 6 x 6 inches and 12 x 12 inches (15 x 15 centimeters and 30 x 30 centimeters).

389096

\*Trademark

©ETHICON, INC. 1986

## VICRYL\* Woven Mesh

### DESCRIPTION

VICRYL\* (polyglactin 910) woven mesh is prepared from a synthetic absorbable copolymer of glycolide and lactide, derived respectively from glycolic and lactic acids. This tightly woven mesh is prepared from uncoated, undyed fiber identical in composition to that used in VICRYL\* (polyglactin 910) synthetic absorbable suture, which has been found to be inert, nonantigenic, nonpyrogenic and to elicit only a mild tissue reaction during absorption.

VICRYL woven mesh is intended for use as a buttress to provide temporary support during the healing process.

### ACTIONS

Two important characteristics describe the in vivo function and behavior of VICRYL woven mesh: reinforced wound strength and the rate of absorption (loss of mass).

The dehiscence force of healing abdominal wounds in rats closed with size 4-0 absorbable sutures was compared with corresponding wounds closed with size 4-0 absorbable sutures and reinforced with VICRYL woven mesh. In this animal model, the strength of the incision, when supported by the mesh, was significantly greater than the sutured incisional wound. Explanted VICRYL woven mesh, which, before implantation had an initial average burst strength of approximately 121 lbs., was found to have approximately 23% of its original burst strength remaining after fourteen days in vivo.

Subcutaneous implantation studies in rats indicate that the absorption of VICRYL mesh material is minimal until about six weeks post implantation and essentially complete between 60 and 90 days.

### INDICATIONS

VICRYL woven mesh may be used wherever temporary wound or organ support is required. The woven mesh structure is less porous than VICRYL knitted mesh. It is indicated in instances in which containment of wound transudate is desirable. VICRYL woven mesh may be cut to the shape or size desired for each specific application.

### CONTRAINDICATIONS

Because VICRYL woven mesh is absorbable, it should not be used where extended wound or organ support is required.

### WARNINGS

DO NOT RESTERILIZE.

The safety and effectiveness of VICRYL woven mesh in neural tissue and in cardiovascular tissue has not been established.

### PRECAUTIONS

None.

### ADVERSE REACTIONS

None known.

### DIRECTIONS FOR USE

It is recommended that absorbable or nonabsorbable sutures be placed 1/4 to 1/2 inch (6 to 12mm) apart at a distance at least 1/4 inch (6mm) from the edge of the mesh. Some surgeons prefer to suture a mesh larger than the defect into position over the defect. The edges are then sutured to assure proper closure under correct tension. When all margin sutures have been placed, the excess mesh is trimmed away, leaving at least 1/4 inch of mesh extending beyond the suture line.

### HOW SUPPLIED

VICRYL woven mesh is available in single packets as a sterile, undyed, fabric mesh in single sheet sizes of approximately 6 x 6 inches and 12 x 12 inches (15 x 15 centimeters and 30 x 30 centimeters).

389065

\*Trademark

©ETHICON, INC. 1986

**INDEX**



**A**

**ABDOMEN**, 23, 26, 28, 30  
 abdominal cavity, 23, 26, 30, 34, 51, 63  
 abdominal wall, 16, 19, 23, 28, 30-31, 33-34, 77, 82, 84  
 fascia, 2, 5, 21, 30-32, 34, 39-40, 47-48, 51, 63, 77, 82, 96  
 muscle tissue, 2, 30  
 peritoneum, 19, 23, 29-31, 34, 47-48, 51, 63  
 skin, 2, 31-33  
 subcutaneous fat, 30-32, 47-48  
 subcuticular tissue, 32  
 transversalis fascia, 30

**ALIMENTARY TRACT**, 35  
 esophagus, 36  
 oral cavity, 35-36, 47-48, 69, 89  
 pharynx, 35, 47-48  
 upper alimentary tract, 35

**B**

**BILIARY TRACT**, 6, 29, 38, 47-48  
 gallbladder, 29

**BONE**, 2, 16, 39-40, 80  
 anchor, 18, 39, 65  
 sternum, 39

**BRAIN**, 34  
 cerebrospinal fluid, 34  
 dura mater, 34-35  
 galea, 34, 76  
 peripheral nerve repair, 34  
 skull, 35

**C**

**CARDIOVASCULAR SURGERY**, 18, 37, 46, 51, 83  
 heart valves, 21, 38, 99  
 pledgets, 18, 21, 38, 91, 101  
 sternum, 16, 37, 39, 48

**COATED VICRYL\***  
**(POLYGLACTIN 910) SUTURE**, 15, 25, 88, 111

**COATED VICRYL\* PLUS**  
**(POLYGLACTIN 910) SUTURE**, 10, 12, 26, 28, 38, 58, 80, 89

**COATED VICRYL RAPIDE\***  
**(POLYGLACTIN 910) SUTURE**, 14, 32-33, 39, 90

**D**

**DEAD SPACE**, 5, 22, 32, 81  
**DERMABOND\***  
**TOPICAL SKIN ADHESIVE**  
**(2-OCTYL CYANOACRYLATE)**, 68-71, 81, 91-92  
**DISSECTION**, 4, 48, 103

**E**

**ETHIBOND\* EXCEL POLYESTER SUTURE**, 10, 17-18, 20, 25, 33, 37-38, 58-59, 81, 83, 93  
**ETHILON\* NYLON SUTURE**, 10, 17, 20, 25, 33-36, 58-59, 81, 94  
**EYE**, 35-36  
 conjunctiva, 35-36, 100  
 cornea, 35-36, 80  
 ocular muscles, 35-36  
 sclera, 35-36

**F**

**FEMALE GENITAL TRACT**, 38

**G**

**GASTROINTESTINAL TRACT**, 6, 28-29, 47-48  
 colon, 2, 27, 29  
 rectum, 29  
 small intestine, 2, 28-29, 94  
 stomach, 2-3, 27-29, 81, 94, 110

**H**

**HIGH VISCOSITY DERMABOND\***  
**TOPICAL SKIN ADHESIVE**  
**(2-OCTYL CYANOACRYLATE)**, 69, 91-92

**I**

**INCISION**, 4-6, 24, 28, 30-32, 49, 59, 62, 68  
**INFLAMMATORY RESPONSE**, 6-7, 77, 94, 110



**K**

**KNOT SECURITY**, 11, 15, 24, 92-93, 95, 97-103, 105

**KNOT TENSILE STRENGTH**, 11, 89

**KNOT TYING**, 17, 23-26, 34, 65, 94

endoscopic, 25-26, 38, 51

monofilament sutures, 11, 18, 24, 29, 32-33, 35, 37, 95, 105

multifilament sutures, 11, 24, 29, 31-33, 36

techniques, 18, 25-26  
deep tie, 25-26

instrument tie, 24-26

square knot, 25-26

surgeon's knot, 25-26

**L**

**LIGATURES**, 10, 18-19, 28, 62, 85

free tie, 18-19, 28

LIGAPAK\* dispensing reel, 21, 59, 63, 82, 101, 110

stick tie, 18-19, 85

**M**

**MERSILENE\***

**POLYESTER FIBER MESH**, 82, 97

**MERSILENE\***

**POLYESTER FIBER STRIP**, 75, 82

**MERSILENE\***

**POLYESTER FIBER SUTURE**, 13, 17, 20, 25, 33, 35, 58-59, 82, 96

**MESH**, 30, 35, 82, 84, 86, 96

*See also* MERSILENE\* polyester fiber mesh; PROLENE\*

Polypropylene Hernia System;

PROLENE\* polypropylene mesh;

VICRYL\* (polyglactin 910)

knitted mesh; VICRYL\*

(polyglactin 910) periodontal

mesh; VICRYL\* (polyglactin 910)

woven mesh

**MICROSURGERY**, 15, 21, 34, 47-48, 62, 65, 82, 97-98, 100

**MONOCRYL\* (POLIGLECAPRONE 25)**

**SUTURE**, 10, 12, 14-15, 20, 25, 32, 38, 58-59, 70-71, 83, 98

**N**

**NECROTIC TISSUE**, 4, 40

**NEEDLE**, 10, 42-54

anatomy, 44

body, 43-54

eye, 44-46

point, 42-44, 47, 48-50

applications, 47-48

shape, 45-50

compound curved, 47

curved, 46-48

half-curved, 47

ski, 47

straight, 46-47

Bunnell, 47, 51

Keith, 47, 51

sharpness, 43, 48-50, 54, 82

stability, 43

strength, 42

ETHALLOY\* needle alloy, 42, 81

swage, 44-45, 65, 83

CONTROL RELEASE\*

needle, 21, 45, 59, 80

types, 48-52

blunt point, 52

ETHIGUARD\* blunt point needle, 52, 81

cutting, 43, 46-50, 51

conventional cutting,

49, 83

PC PRIME\* needle, 48-49, 83

sternotomy, 49

reverse cutting, 49-50, 75, 84

MICRO-POINT\*

needle, 49, 82

OS, 50, 51

side-cutting, 50, 82

CS ULTIMA\*

needle, 48, 50, 80

SABRELOC\*

needle, 50, 84

spatula, 50-51, 82

TG PLUS\* needle, 50

taper point, 21, 43, 46,  
50-51, 77, 85  
MAYO, 51  
TAPERCUT, 44, 48, 50-51  
TAPERCUT needle,  
44, 48, 51-52,  
85  
trocar point, 51

**NEEDLEHOLDER**, 26-27, 42-43, 46-53  
arming, 27, 59  
jaws, 52

**NEUROSURGERY**, 16, 34

**NUROLON\* BRAIDED NYLON**

**SUTURE**, 10, 13, 17, 20, 25, 34, 39,  
58-59, 83, 100

## O

**OPHTHALMIC SURGERY**, 15, 35, 47, 49  
66, 80, 83

**ORTHOPAEDIC SURGERY**, 18, 50, 51

## P

**PARENCHYMATOUS ORGANS**, 29

kidney, 3, 29, 52  
liver, 29-30, 52  
spleen, 29

**PDS\* II (POLYDIOXANONE) SUTURE**,  
10, 15-16, 25, 31, 35, 38,  
59-60, 83, 101

**PERMA-HAND\* SILK SUTURE**, 16, 25,  
33, 59, 83, 102

**PLASTIC SURGERY**, 14, 17, 48, 51, 57,  
83-84

**PRIMARY SUTURE LINE**, 18, 22-23, 33  
buried sutures, 22, 80  
continuous sutures, 19, 22, 37  
Connell Technique, 24  
Cushing Technique, 24  
Lembert Technique, 24  
deep sutures, 19, 22, 69  
interrupted sutures, 19, 22, 28,  
30-31, 38  
interrupted horizontal  
mattress suture, 19, 24  
interrupted vertical  
mattress suture, 19, 24

purse-string sutures, 19, 22  
running stitches, 19  
subcuticular sutures, 19, 22,  
32, 90

**PROLENE\* POLYPROPYLENE HERNIA  
SYSTEM**, 30, 70, 84, 104

**PROLENE\* POLYPROPYLENE MESH**,  
30, 70, 84, 105

**PROLENE\* POLYPROPYLENE SUTURE**,  
18, 20, 25-26, 28, 30-31, 34-35,  
37, 39, 61, 84, 103

**PRONOVA\* POLY  
(HEXAFLUOROPROPYLENE-VDF)**

**SUTURE**, 18, 20, 25-26, 37, 39, 84

**PROXI-STRIP\* SKIN CLOSURES**, 27,  
40, 75, 84

## R

**RESPIRATORY TRACT**, 36

bronchial stump closure, 36  
thoracic cavity, 36

**RETENTION SUTURE DEVICES**, 33,  
77-78, 84

## S

**SECONDARY SUTURE LINE**, 33

continuous sutures, 19, 22, 24,  
37  
interrupted sutures, 19, 22, 24,  
28, 30-31, 37

railroad track scar, 33

retention sutures, 33, 77-78, 84

**SKIN**, 2-5, 8, 10, 13-14, 16-17, 22,  
27-28, 31-34, 46-47

**STITCH PLACEMENT**, 23

**STITCHES AND TYPES**, 18-23

Connell Technique, 24

Cushing Technique, 24

Halsted Technique, 24

horizontal mattress technique,  
19, 24

Lembert Technique, 24

over-and-over technique, 19, 24

purse-string technique, 19, 22

running technique, 19

- subcuticular technique, 19, 22
- vertical mattress technique, 19, 24
- SURGICAL GUT SUTURE**, 14, 20, 58, 94, 110
  - chromic, 13-14, 20, 28, 32-33, 38, 80, 94, 97, 110
  - CHROMICIZING process, 14
  - collagen pure, 12-14
  - fast absorbing, 14, 27, 94
  - plain, 12-14, 20, 83, 94, 110
  - TRU-GAUGING process, 13, 85
  - tubing fluid, 85
- SURGICAL SILK SUTURE**, 16, 28, 34
  - See also* PERMA-HAND\* silk suture
- SURGICAL STAINLESS STEEL SUTURE**, 16-17, 20, 25, 66, 111
- SUTURE**, 10-40
  - absorbable suture, 15, 22, 27-32, 38, 58-60, 80, 83, 85, 89
  - See also* Coated VICRYL\* (polyglactin 910) suture; Coated VICRYL RAPIDE\* (polyglactin 910) suture; MONOCRYL\* (poliglecaprone 25) suture; PDS\* II (polydioxanone) suture; surgical gut suture
  - alloy suture, 16, 42, 49, 51, 81
    - wire gauge equivalents, 17
  - See also* surgical stainless steel suture; temporary cardiac pacing wire
  - antibacterial suture, 10, 15, 20-21
    - VICRYL\* (polyglactin 910) plus suture
  - characteristics, 10-11, 14, 16-17, 24, 32
    - absorption profile, 20-21
    - hydrolysis, 15, 17, 32, 35
    - absorption rate, 14, 20-21
    - braided strands, 18
    - breaking strength, 2, 20-21
      - in vivo* strength, 20-21
    - burst strength, 2
    - monofilament strands, 11, 15, 17, 24, 31-32, 35
    - multifilament strands, 11, 16-17, 24, 29, 31-33
    - size, 10-11, 13-16, 28
    - tensile strength, 2, 6, 10-17, 23, 27, 31-33, 35, 38, 66, 85
    - tissue reaction, 12, 14-15, 17-18, 26, 32-38
  - labeling, 56-60
    - expiration date, 57, 60, 81
    - Food and Drug Administration (FDA), 12, 57, 60, 68, 81
    - lot number, 57
    - package insert, 57, 83
    - product code, 57, 84
  - manufacture, 13, 16, 42, 57, 90
  - nonabsorbable suture, 16, 18, 22-23, 26, 29, 31-32, 35, 57, 60, 63, 82-83
    - See also* ETHIBOND\* EXCEL polyester suture; ETHILON\* nylon suture; MERSILENE\* polyester fiber suture; NUROLON\* braided nylon suture; PROLENE\* polypropylene suture; PRONOVA\* poly(hexafluoropropylene-VDF) suture; surgical silk suture
      - nylon suture, 10, 13, 17, 20, 25, 36, 40, 81, 83, 93, 99
      - See also* ETHILON\* nylon suture; NUROLON\* braided nylon suture
  - packaging, 10, 16, 56-65

dispenser boxes, 56-57,  
 60, 81, 83  
 environmentally conscious, 57  
 primary packets, 56-57  
 overwrap, 57, 59, 61-62,  
 64, 83  
 peelable foil, 58  
 single strand and multi-  
 strand packaging packets,  
 58, 82-83  
 E-PACK\* procedure  
 kit, 54, 59, 61, 81  
 EASY ACCESS\*  
 packaging, 81  
 ETHI-PACK\* pre-cut  
 suture, 81  
 GENTLE BEND\*  
 package, 82  
 LABYRINTH\*  
 package, 82  
 looped suture, 19,  
 77, 82  
 RELAY\* suture  
 delivery system,  
 56-58, 60-61,  
 64, 84  
 SUTUPAK\* pre-cut  
 sterile suture, 58,  
 63, 85  
 storage racks, 56  
 IV pole racks, 56  
 modular storage  
 racks, 56-57  
 polyester fiber suture, 13, 17, 20,  
 25, 58, 92, 95, 96  
*See also* ETHIBOND\* EXCEL  
 polyester suture  
 polypropylene suture, 18, 25-26,  
 28, 30, 32, 36-39, 66,  
 82-84, 102-103  
*See also* PROLENE\*  
 polypropylene suture  
 sterilization, 57, 60, 85, 90, 104  
**SUTURE CUTTING**, 26  
**SUTURE HANDLING**, 10-11, 26-27, 63  
 sterile barrier, 61  
 sterile field, 53, 56, 59-62, 64

sterile technique, 26, 75, 85  
 sterile transfer, 56, 60-62  
 sterile sterilization, 60  
**SUTURE PREPARATION**, 62  
**SUTURE REMOVAL**, 11, 14, 26, 32-33,  
 35, 68-69  
**SUTURE TECHNIQUES**, 28-34, 45  
 double-layer closure, 28  
 inverted closure technique, 28  
 single-layer closure, 28, 31  
 Smaed-Jones far-and-  
 near technique, 31  
*See also* ligatures; primary suture  
 line; secondary suture line

## T

**TAPES**, 4, 32, 52, 56, 74-75  
 skin closure tapes, 32, 74-75  
 umbilical tape, 75, 85  
*See also* MERSILENE\* polyester  
 fiber strip; PROXI-STRIP\* skin  
 closures  
**TENDON SURGERY**, 39  
 Bunnell Technique, 37, 39  
 periosteum, 39, 51  
**TISSUE ADHESIVES**, 68-71  
*See also* DERMABOND\* Topical  
 Skin Adhesive (2-Octyl  
 Cyanoacrylate)  
**TISSUE STRENGTH**, 2  
 breaking strength, 2  
 burst strength, 2  
 tensile strength, 2, 6, 11-17, 23

## U

**URINARY TRACT SURGERY**, 38

**V****VASCULAR SURGERY, 11**

heart valves, 21, 38, 99

**VESSELS, 4, 6, 10, 14, 18, 24, 32, 37-38, 51, 59, 62, 75**

pediatric, 15, 21, 75, 85

**VICRYL\* (POLYGLACTIN 910)****KNITTED MESH, 30, 86, 112****VICRYL\* (POLYGLACTIN 910)****PERIODONTAL MESH, 35-36, 86****VICRYL\* (POLYGLACTIN 910) SUTURE, 10, 14-15, 25, 34-35****VICRYL\* (POLYGLACTIN 910) PLUS SUTURE, 10, 15, 20-21****VICRYL\* (POLYGLACTIN 910)****WOVEN MESH, 30, 86, 113****W****WOUND CLASSIFICATION, 5-6**

clean, 4-5

clean-contaminated, 5

contaminated, 6-7, 18

dirty and infected, 5-7, 18

**WOUND COMPLICATIONS, 3**

dehiscence, 16, 38, 68, 74, 81

dehydration, 3

edema, 2, 5-6, 11, 78

epithelialization, 7, 33, 35, 68

infection, 2-7, 10-12, 27, 31-32, 35, 35-36, 38-40

wound disruption, 23, 86

**WOUND HEALING, 2-7, 10**

collagen formation, 7

dehydration, 3

primary intention, 6

second intention, 6

delayed primary closure, 6



# NOTES



# NOTES

**ETHICON, INC.**  
a *Johnson & Johnson* company

**WOUND HEALING**

**SUTURES**

**NEEDLES**

**ADHESIVES**

**SURGICAL MESH**

TO VIEW THE E-CATALOG GO TO THE  
HEALTHCARE PROFESSIONAL SECTION OF  
**WWW.ETHICON.COM**

ETHICON, INC. , PO Box 151, SOMERVILLE, NJ 08876-0151

\* TRADEMARK

<sup>SM</sup> ETHICON, INC.

© 2005, ETHICON, INC.

**ETHICON, INC.**  
a *Johnson & Johnson* company

**WOUND CLOSURE MANUAL**